

# 6 Series Weld Fittings

Fittings

Valves and Filters

Manifolds

Tubing, Pipes, Hoses and Connectors

Quick-connects, Vessels and Sample Cylinders

Tubing Tools, Other Elements



# Contents

## Tube Butt Weld Fittings

### Male Connectors - WM



A-140

### Female Connectors - WF



A-141

### Reducing Unions - WU



A-141

### Union Elbows - WLU



A-142

### Union Tees - WT

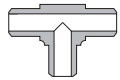

A-142

### Union Crosses - WC

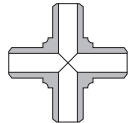

A-143

## Tube Socket Weld Fittings

### Male Connectors - WM



A-143

### Female Connectors - WF



A-144

### Male Elbows - WLM



A-145

### Female Elbows - WLF



A-145

### Unions - WU



A-146

### Reducing Unions - WU



A-146

### Union Elbows - WLU



A-147

### Union 45° Elbows - WV



A-147

### Union Tees - WT

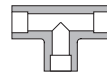

A-148

### Union Crosses - WC

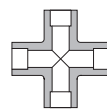

A-148

## Pipe Butt Weld Fittings

### Male Connectors - WM



A-149

### Female Connectors - WF



A-149

## Pipe Socket Weld Fittings

### Male Connectors - WM



A-150

### Female Connectors - WF



A-150

### Unions - WU



A-151

## Weld Adapters

### Tube Butt Weld to Tube Socket Weld - WA



A-151

### Pipe Butt Weld to Tube Socket Weld - WA



A-151

## Pipe to Weld Fittings

### Pipe to Tube Butt Weld - PUW



A-152

### Male Pipe to Tube Butt Weld - MUW

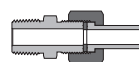

A-153

### Part Number Description

A-154

Fittings

Valves and Filters

Manifolds

Tubing, Pipes, Hoses  
and ConnectorsQuick-connects, Vessels  
and Sample CylindersTubing Tools,  
Other Elements

## Features

- ⦿ 316 stainless steel is standard material. Other materials are available upon request.
- ⦿ Straight fittings are manufactured from quality bar stock. Shaped fittings are made from forging.
- ⦿ Quality machining of all ports ensures consistent welding.
- ⦿ Radius junction design with elbows provides smooth flow path.
- ⦿ All fittings are cleaned to remove oil, grease and loose particles.
- ⦿ Every fitting is stamped with size, material and heat code.

## Technical Data

- ⦿ Sizes range from 1/8" to 2" and 6 mm to 38 mm.
- ⦿ Working Temperature:

Material	Minimum Temperature	Maximum Temperature
316 stainless steel	-325°F (-198°C)	1000°F (538°C)
316L stainless steel	-325°F (-198°C)	850°F (454°C)
904L stainless steel	-325°F (-198°C)	700°F (371°C)

- ⦿ Working Pressure:

1. Catalog working pressures shown are based on ANSI/ASME B31.3 at ambient temperature, to determine working pressures in accordance with ANSI/ASME B31.1, multiply catalog working pressures shown by 0.94.
2. Use the allowable working pressure at ambient temperature to multiply the elevated temperature factors to get the working pressure at elevated temperature. To know the elevated temperature factor, please refer to the related information of FITOK Tubes and Pipes in page D-14.

## Materials

Material	Bar Stock	Forgings	Designator
316 stainless steel	ASTM A276, ASME SA479	ASTM A182, ASME SA182	SS
316L stainless steel			6L
904L stainless steel	ASTM B649	ASTM A182	904L

- ⦿ *Using the same materials to weld will ensure the same coefficients of expansion and good welding.*
- ⦿ *Tungsten Inert Gas Welding (TIG) is recommended.*

# Tube Butt Weld Fittings

## Male Connectors

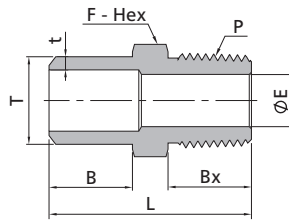

Fractional Tube				NPT Thread					Working Pressure psig (bar)
T-Tube O.D. (in.)	t-Wall Thickness (in.)	P-NPT Size	Basic Ordering Number	Dimension, in. (mm)					
				L	B	Bx	F	E	
1/4	0.065	1/4	-WM-TB4-NS4	1.17 (29.7)	0.38 (9.7)	0.56 (14.2)	0.56 (14.3)	0.28 (7.1)	8000 (551)
1/4	0.065	1/2	-WM-TB4-NS8	1.45 (36.8)	0.38 (9.7)	0.75 (19.1)	0.87 (22.2)	0.47 (11.9)	7700 (530)
3/8	0.095	1/4	-WM-TB6-NS4	1.17 (29.7)	0.38 (9.7)	0.56 (14.2)	0.56 (14.3)	0.28 (7.1)	8000 (551)
3/8	0.095	1/2	-WM-TB6-NS8	1.45 (36.8)	0.38 (9.7)	0.75 (19.1)	0.87 (22.2)	0.47 (11.9)	7700 (530)
1/2	0.095	1/4	-WM-TB8-NS4	1.35 (34.3)	0.56 (14.2)	0.56 (14.2)	0.56 (14.3)	0.28 (7.1)	6780 (468)
1/2	0.095	1/2	-WM-TB8-NS8	1.63 (41.4)	0.56 (14.2)	0.75 (19.1)	0.87 (22.2)	0.47 (11.9)	6780 (468)
5/8	0.109	1/4	-WM-TB10-NS4	1.37 (34.8)	0.56 (14.2)	0.56 (14.2)	0.69 (17.5)	0.28 (7.1)	5760 (397)
5/8	0.109	1/2	-WM-TB10-NS8	1.63 (41.4)	0.56 (14.2)	0.75 (19.1)	0.87 (22.2)	0.47 (11.9)	5760 (397)
3/4	0.120	1/4	-WM-TB12-NS4	1.58 (40.1)	0.75 (19.1)	0.56 (14.2)	0.81 (20.6)	0.28 (7.1)	5530 (381)
3/4	0.120	1/2	-WM-TB12-NS8	1.82 (46.2)	0.75 (19.1)	0.75 (19.1)	0.87 (22.2)	0.47 (11.9)	5530 (381)
1	0.134	1/4	-WM-TB16-NS4	1.69 (42.9)	0.75 (19.1)	0.56 (14.2)	1.06 (27.0)	0.28 (7.1)	4480 (309)
1	0.134	1/2	-WM-TB16-NS8	1.88 (47.8)	0.75 (19.1)	0.75 (19.1)	1.06 (27.0)	0.47 (11.9)	4480 (309)

Metric Tube				NPT Thread					Working Pressure psig (bar)
T-Tube O.D. (mm)	t-Wall Thickness (mm)	P-NPT Size	Basic Ordering Number	Dimension, mm (in.)					
				L	B	Bx	F	E	
12	2.2	1/4	-WM-MTB12-NS4	34.3 (1.35)	14.2 (0.56)	14.2 (0.56)	14.0 (0.55)	7.1 (0.28)	6470 (446)
12	2.2	1/2	-WM-MTB12-NS8	41.1 (1.62)	14.2 (0.56)	19.1 (0.75)	22.0 (0.87)	11.9 (0.47)	6470 (446)
14	2.5	1/4	-WM-MTB14-NS4	34.3 (1.35)	14.2 (0.56)	14.2 (0.56)	15.0 (0.59)	7.1 (0.28)	6280 (433)
14	2.5	1/2	-WM-MTB14-NS8	41.4 (1.63)	14.2 (0.56)	19.1 (0.75)	22.0 (0.87)	11.9 (0.47)	6280 (433)
15	2.5	1/4	-WM-MTB15-NS4	34.8 (1.37)	14.2 (0.56)	14.2 (0.56)	16.0 (0.63)	7.1 (0.28)	5770 (398)
16	2.8	1/4	-WM-MTB16-NS4	35.6 (1.40)	14.2 (0.56)	14.2 (0.56)	18.0 (0.71)	7.1 (0.28)	6140 (423)
16	2.8	1/2	-WM-MTB16-NS8	41.1 (1.62)	14.2 (0.56)	19.1 (0.75)	22.0 (0.87)	11.9 (0.47)	6140 (423)
20	3.0	1/2	-WM-MTB20-NS8	46.2 (1.82)	19.1 (0.75)	19.1 (0.75)	22.0 (0.87)	11.9 (0.47)	5110 (352)
22	3.0	1/4	-WM-MTB22-NS4	41.2 (1.62)	19.1 (0.75)	14.2 (0.56)	24.0 (0.94)	7.1 (0.28)	4620 (319)
22	3.0	1/2	-WM-MTB22-NS8	46.1 (1.81)	19.1 (0.75)	19.1 (0.75)	24.0 (0.94)	11.9 (0.47)	4620 (319)
25	3.5	3/4	-WM-MTB25-NS12	47.8 (1.88)	19.1 (0.75)	19.1 (0.75)	27.0 (1.06)	15.7 (0.62)	4730 (326)
25	3.5	1	-WM-MTB25-NS16	54.9 (2.16)	19.1 (0.75)	23.9 (0.94)	35.0 (1.38)	22.4 (0.88)	4730 (326)
28	4.0	1/2	-WM-MTB28-NS8	54.2 (2.13)	21.4 (0.84)	19.1 (0.75)	30.0 (1.18)	11.9 (0.47)	4850 (335)

Dimensions are for reference only, subject to change.

Female Connectors

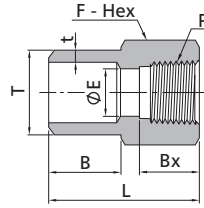

Fractional Tube				Dimension, in. (mm)					NPT Thread	Working Pressure psig (bar)
T-Tube O.D. (in.)	t-Wall Thickness (in.)	P-NPT Size	Basic Ordering Number	L	B	Bx	F	E		
1/4	0.065	1/4	-WF-TB4-NS4	1.10 (27.9)	0.38 (9.7)	0.59 (15.0)	0.75 (19.1)	0.12 (3.0)	6600 (454)	
1/4	0.065	3/8	-WF-TB4-NS6	1.16 (29.5)	0.38 (9.7)	0.59 (15.0)	0.87 (22.2)	0.12 (3.0)	5300 (365)	
3/8	0.095	1/4	-WF-TB6-NS4	1.10 (27.9)	0.38 (9.7)	0.59 (15.0)	0.75 (19.1)	0.19 (4.7)	6600 (454)	
3/8	0.095	3/8	-WF-TB6-NS6	1.16 (29.5)	0.38 (9.7)	0.59 (15.0)	0.87 (22.2)	0.19 (4.7)	5300 (365)	
1/2	0.095	1/4	-WF-TB8-NS4	1.34 (34.0)	0.56 (14.2)	0.59 (15.0)	0.75 (19.1)	0.31 (7.9)	6600 (454)	
1/2	0.095	3/8	-WF-TB8-NS6	1.34 (34.0)	0.56 (14.2)	0.59 (15.0)	0.87 (22.2)	0.31 (7.9)	5300 (365)	
1/2	0.095	1/2	-WF-TB8-NS8	1.53 (38.9)	0.56 (14.2)	0.78 (19.8)	1.06 (27.0)	0.31 (7.9)	4900 (337)	

Metric Tube				Dimension, mm (in.)					NPT Thread	Working Pressure psig (bar)
T-Tube O.D. (mm)	t-Wall Thickness (mm)	P-NPT Size	Basic Ordering Number	L	B	Bx	F	E		
14	2.5	1/4	-WF-MTB14-NS4	33.0 (1.30)	14.2 (0.56)	15.0 (0.59)	19.0 (0.75)	9.0 (0.35)	6280 (433)	
14	2.5	1/2	-WF-MTB14-NS8	38.9 (1.53)	14.2 (0.56)	19.8 (0.78)	27.0 (1.06)	9.0 (0.35)	4900 (337)	
20	3.0	1/2	-WF-MTB20-NS8	43.7 (1.72)	19.1 (0.75)	19.8 (0.78)	27.0 (1.06)	14.0 (0.55)	4900 (337)	
28	4.0	1/2	-WF-MTB28-NS8	49.8 (1.96)	23.9 (0.94)	19.8 (0.78)	30.0 (1.18)	15.7 (0.62)	4850 (335)	

Reducing Unions

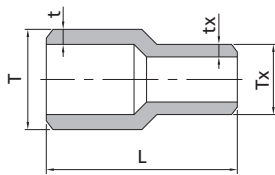

Fractional Tube				Fractional Tube		
T-Tube O.D. (in.)	t-Wall Thickness (in.)	Tx-Tube O.D. (in.)	tx-Wall Thickness (in.)	Basic Ordering Number	L in. (mm)	Working Pressure psig (bar)
3/8	0.095	1/4	0.065	-WU-TB6-TB4	1.50 (38.1)	9930 (685)
1/2	0.095	1/4	0.065	-WU-TB8-TB4	1.50 (38.1)	6780 (468)
1/2	0.095	3/8	0.095	-WU-TB8-TB6	1.50 (38.1)	6780 (468)
3/4	0.120	1/2	0.095	-WU-TB12-TB8	1.50 (38.1)	5530 (381)
1	0.134	3/4	0.120	-WU-TB16-TB12	1.50 (38.1)	4480 (309)

Metric Tube				Metric Tube		
T-Tube O.D. (mm)	t-Wall Thickness (mm)	Tx-Tube O.D. (mm)	tx-Wall Thickness (mm)	Basic Ordering Number	L mm (in.)	Working Pressure psig (bar)
20	3.0	14	2.5	-WU-MTB20-MTB14	38.1 (1.50)	6470 (445)
22	3.0	14	2.5	-WU-MTB22-MTB14	38.1 (1.50)	5780 (395)
22	3.0	18	2.8	-WU-MTB22-MTB18	38.1 (1.50)	5780 (395)
25	3.5	22	3.0	-WU-MTB25-MTB22	38.1 (1.50)	5780 (395)
38	5.0	25	3.5	-WU-MTB38-MTB25	38.1 (1.50)	5540 (380)

## Union Elbows

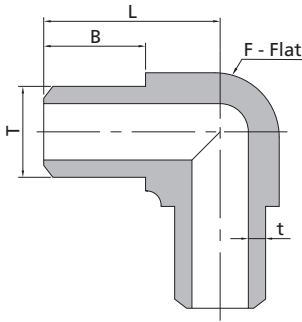

## Fractional Tube

T-Tube O.D. (in.)	t-Wall Thickness (in.)	Basic Ordering Number	Dimension, in. (mm)			Working Pressure psig (bar)
			L	B	F	
1/4	0.065	-WLU-TB4	0.64 (16.3)	0.38 (9.7)	0.37 (9.5)	10320 (712)
3/8	0.095	-WLU-TB6	0.71 (18.0)	0.38 (9.7)	0.44 (11.1)	9930 (685)
1/2	0.095	-WLU-TB8	0.96 (24.4)	0.56 (14.2)	0.56 (14.3)	6780 (468)
3/4	0.120	-WLU-TB12	1.31 (33.3)	0.75 (19.1)	0.81 (20.6)	5530 (381)
1	0.134	-WLU-TB16	1.46 (37.1)	0.75 (19.1)	1.06 (27.0)	4480 (309)

## Metric Tube

T-Tube O.D. (mm)	t-Wall Thickness (mm)	Basic Ordering Number	Dimension, mm (in.)			Working Pressure psig (bar)
			L	B	F	
10	2.2	-WLU-MTB10	18.0 (0.71)	9.7 (0.38)	11.1 (0.44)	8160 (563)
14	2.5	-WLU-MTB14	25.4 (1.00)	14.2 (0.56)	15.9 (0.63)	6280 (433)
16	2.8	-WLU-MTB16	26.2 (1.03)	14.2 (0.56)	17.5 (0.69)	6140 (423)
20	3.0	-WLU-MTB20	33.3 (1.31)	19.1 (0.75)	20.6 (0.81)	5110 (352)
22	3.0	-WLU-MTB22	35.3 (1.39)	19.1 (0.75)	23.8 (0.94)	4620 (319)
25	3.5	-WLU-MTB25	37.1 (1.46)	19.1 (0.75)	27.0 (1.06)	4730 (326)

## Union Tees

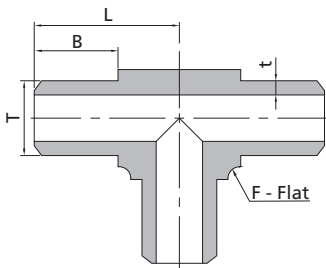

## Fractional Tube

T-Tube O.D. (in.)	t-Wall Thickness (in.)	Basic Ordering Number	Dimension, in. (mm)			Working Pressure psig (bar)
			L	B	F	
1/4	0.065	-WT-TB4	0.64 (16.3)	0.38 (9.7)	0.37 (9.5)	10320 (712)
3/8	0.095	-WT-TB6	0.71 (18.0)	0.38 (9.7)	0.44 (11.1)	9930 (685)
1/2	0.095	-WT-TB8	0.96 (24.4)	0.56 (14.2)	0.56 (14.3)	6780 (468)
3/4	0.120	-WT-TB12	1.31 (33.3)	0.75 (19.1)	0.81 (20.6)	5530 (381)
1	0.134	-WT-TB16	1.46 (37.1)	0.75 (19.1)	1.06 (27.0)	4480 (309)

## Metric Tube

T-Tube O.D. (mm)	t-Wall Thickness (mm)	Basic Ordering Number	Dimension, mm (in.)			Working Pressure psig (bar)
			L	B	F	
6	1.8	-WT-MTB6	16.3 (0.64)	9.7 (0.38)	9.5 (0.37)	12660 (873)
8	1.8	-WT-MTB8	16.3 (0.64)	9.7 (0.38)	9.5 (0.37)	8320 (574)
10	2.2	-WT-MTB10	18.0 (0.71)	9.7 (0.38)	11.1 (0.44)	8160 (563)
12	2.2	-WT-MTB12	24.4 (0.96)	14.2 (0.56)	14.3 (0.56)	6470 (446)
14	2.5	-WT-MTB14	25.4 (1.00)	14.2 (0.56)	15.9 (0.63)	6280 (433)
16	2.8	-WT-MTB16	26.2 (1.03)	14.2 (0.56)	17.5 (0.69)	6140 (423)
20	3.0	-WT-MTB20	33.3 (1.31)	19.1 (0.75)	20.6 (0.81)	5110 (352)
22	3.0	-WT-MTB22	35.3 (1.39)	19.1 (0.75)	23.8 (0.94)	4620 (319)
25	3.5	-WT-MTB25	37.1 (1.46)	19.1 (0.75)	27.0 (1.06)	4730 (326)
32	4.5	-WT-MTB32	49.3 (1.94)	23.9 (0.94)	34.9 (1.37)	4730 (326)

Fittings

Valves and Filters

Manifolds

Tubing, Pipes, Hoses and Connectors

Quick-connects, Vessels and Sample Cylinders

Tubing Tools, Other Elements

Union Crosses

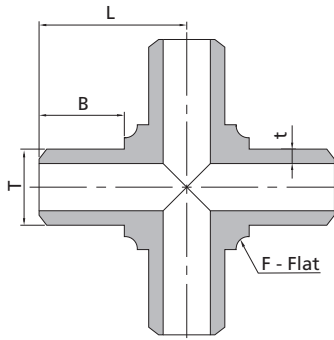

Fractional Tube						
T-Tube O.D. (in.)	t-Wall Thickness (in.)	Basic Ordering Number	Dimension, in. (mm)			Working Pressure psig (bar)
			L	B	F	
1/4	0.065	-WC-TB4	0.64 (16.3)	0.38 (9.7)	0.37 (9.5)	10320 (712)
3/8	0.095	-WC-TB6	0.71 (18.0)	0.38 (9.7)	0.44 (11.1)	9930 (685)
1/2	0.095	-WC-TB8	0.96 (24.4)	0.56 (14.2)	0.56 (14.3)	6780 (468)
3/4	0.120	-WC-TB12	1.31 (33.3)	0.75 (19.1)	0.81 (20.6)	5530 (381)
1	0.134	-WC-TB16	1.46 (37.1)	0.75 (19.1)	1.06 (27.0)	4480 (309)

Metric Tube						
T-Tube O.D. (mm)	t-Wall Thickness (mm)	Basic Ordering Number	Dimension, mm (in.)			Working Pressure psig (bar)
			L	B	F	
6	1.8	-WC-MTB6	16.3 (0.64)	9.7 (0.38)	9.5 (0.37)	12660 (873)
8	1.8	-WC-MTB8	16.3 (0.64)	9.7 (0.38)	9.5 (0.37)	8320 (574)
10	2.2	-WC-MTB10	18.0 (0.71)	9.7 (0.38)	11.1 (0.44)	8160 (563)

Tube Socket Weld Fittings

Male Connectors

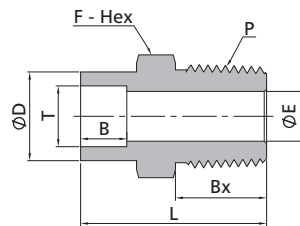

Fractional Tube							NPT Thread		
T-Tube Size (in.)	P-NPT Size	Basic Ordering Number	Dimension, in. (mm)					Working Pressure psig (bar)	
			L	D	B	Bx	F		E
1/4	1/4	-WM-TS4-NS4	1.15 (29.2)	0.48 (12.2)	0.28 (7.1)	0.56 (14.2)	0.56 (14.3)	0.19 (4.8)	8000 (551)
3/8	1/4	-WM-TS6-NS4	1.25 (31.8)	0.60 (15.2)	0.31 (7.9)	0.56 (14.2)	0.63 (15.9)	0.28 (7.1)	8000 (551)
3/8	3/8	-WM-TS6-NS6	1.25 (31.8)	0.60 (15.2)	0.31 (7.9)	0.56 (14.2)	0.69 (17.5)	0.28 (7.1)	7800 (537)
3/8	1/2	-WM-TS6-NS8	1.47 (37.3)	0.60 (15.2)	0.31 (7.9)	0.75 (19.1)	0.87 (22.2)	0.28 (7.1)	7700 (530)
1/2	1/4	-WM-TS8-NS4	1.31 (33.3)	0.73 (18.5)	0.38 (9.7)	0.56 (14.2)	0.75 (19.1)	0.28 (7.1)	6600 (454)
1/2	3/8	-WM-TS8-NS6	1.31 (33.3)	0.73 (18.5)	0.38 (9.7)	0.56 (14.2)	0.75 (19.1)	0.38 (9.6)	6600 (454)
1/2	1/2	-WM-TS8-NS8	1.53 (38.9)	0.73 (18.5)	0.38 (9.7)	0.75 (19.1)	0.87 (22.2)	0.41 (10.4)	6600 (454)
3/4	3/4	-WM-TS12-NS12	1.78 (45.1)	1.04 (26.4)	0.44 (11.2)	0.75 (19.1)	1.06 (27.0)	0.62 (15.7)	5900 (406)
1	1	-WM-TS16-NS16	2.11 (53.6)	1.36 (34.5)	0.62 (15.7)	0.94 (23.9)	1.37 (34.9)	0.88 (22.4)	5300 (365)

Metric Tube			NPT Thread						
T-Tube Size (mm)	P-NPT Size	Basic Ordering Number	Dimension, mm (in.)						Working Pressure psig (bar)
			L	D	B	Bx	F	E	
6	1/4	-WM-MTS6-NS4	29.2 (1.15)	12.0 (0.47)	7.1 (0.28)	14.2 (0.56)	14.0 (0.55)	4.8 (0.19)	8000 (551)
12	1/2	-WM-MTS12-NS8	38.9 (1.53)	20.2 (0.80)	9.7 (0.38)	19.1 (0.75)	22.0 (0.87)	9.5 (0.37)	6820 (470)
14	1/4	-WM-MTS14-NS4	33.3 (1.31)	23.8 (0.94)	10.0 (0.39)	14.2 (0.56)	24.0 (0.94)	7.1 (0.28)	6930 (478)
14	3/8	-WM-MTS14-NS6	35.0 (1.38)	23.8 (0.94)	10.0 (0.39)	14.2 (0.56)	24.0 (0.94)	9.6 (0.38)	6930 (478)
14	1/2	-WM-MTS14-NS8	40.0 (1.57)	23.8 (0.94)	10.0 (0.39)	19.1 (0.75)	24.0 (0.94)	10.4 (0.41)	6930 (478)
16	1/4	-WM-MTS16-NS4	35.0 (1.38)	23.8 (0.94)	10.4 (0.41)	14.2 (0.56)	24.0 (0.94)	7.1 (0.28)	6190 (426)
16	1/2	-WM-MTS16-NS8	40.0 (1.57)	23.8 (0.94)	10.4 (0.41)	19.1 (0.75)	24.0 (0.94)	11.9 (0.47)	6190 (426)
18	1/4	-WM-MTS18-NS4	40.1 (1.58)	26.0 (1.02)	11.2 (0.44)	14.2 (0.56)	27.0 (1.06)	7.1 (0.28)	6050 (417)
28	3/4	-WM-MTS28-NS12	55.5 (2.19)	40.0 (1.57)	20.0 (0.79)	19.1 (0.75)	41.0 (1.61)	15.7 (0.62)	5040 (348)
38	1 1/4	-WM-MTS38-NS20	68.3 (2.69)	50.8 (2.00)	22.0 (0.87)	23.9 (0.94)	52.0 (2.05)	28.6 (1.13)	5000 (344)

## Female Connectors

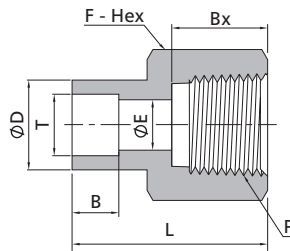

Fractional Tube			NPT Thread						
T-Tube Size (in.)	P-NPT Size	Basic Ordering Number	Dimension, in. (mm)						Working Pressure psig (bar)
			L	D	B	Bx	F	E	
1/8	1/8	-WF-TS2-NS2	0.83 (21.1)	0.29 (7.4)	0.10 (2.5)	0.41 (10.4)	0.56 (14.3)	0.09 (2.3)	6500 (447)
1/4	1/8	-WF-TS4-NS2	1.05 (26.7)	0.48 (12.2)	0.28 (7.1)	0.41 (10.4)	0.56 (14.3)	0.19 (4.8)	6500 (447)
1/4	1/4	-WF-TS4-NS4	1.18 (30.0)	0.48 (12.2)	0.28 (7.1)	0.59 (15.0)	0.75 (19.1)	0.19 (4.8)	6600 (454)
3/8	1/4	-WF-TS6-NS4	1.24 (31.5)	0.60 (15.2)	0.31 (7.9)	0.59 (15.0)	0.75 (19.1)	0.28 (7.1)	6600 (454)
1/2	3/8	-WF-TS8-NS6	1.36 (34.5)	0.73 (18.5)	0.38 (9.7)	0.59 (15.0)	0.87 (22.2)	0.41 (10.4)	5300 (365)
1/2	1/2	-WF-TS8-NS8	1.59 (40.4)	0.73 (18.5)	0.38 (9.7)	0.78 (19.8)	1.06 (27.0)	0.41 (10.4)	4900 (337)
3/4	3/4	-WF-TS12-NS12	1.73 (43.9)	1.04 (26.4)	0.44 (11.2)	0.81 (20.6)	1.31 (33.3)	0.63 (16.0)	4600 (316)
1	1	-WF-TS16-NS16	2.13 (54.1)	1.36 (34.5)	0.62 (15.7)	1.00 (25.4)	1.63 (41.3)	0.88 (22.4)	4400 (303)

Metric Tube			NPT Thread						
T-Tube Size (mm)	P-NPT Size	Basic Ordering Number	Dimension, mm (in.)						Working Pressure psig (bar)
			L	D	B	Bx	F	E	
8	1/4	-WF-MTS8-NS4	27.0 (1.06)	14.3 (0.56)	7.9 (0.31)	15.0 (0.59)	19.0 (0.75)	4.8 (0.19)	6600 (454)
10	1/4	-WF-MTS10-NS4	29.0 (1.14)	16.5 (0.65)	7.9 (0.31)	15.0 (0.59)	19.0 (0.75)	7.1 (0.28)	6600 (454)
14	1/4	-WF-MTS14-NS4	32.0 (1.26)	23.8 (0.94)	10.0 (0.39)	15.0 (0.59)	24.0 (0.94)	9.5 (0.37)	6930 (478)
28	3/4	-WF-MTS28-NS12	54.1 (2.13)	40.0 (1.57)	20.0 (0.79)	20.6 (0.81)	41.0 (1.61)	19.8 (0.78)	4600 (316)



Male Elbows

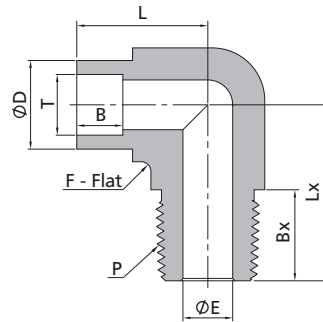

Fractional Tube			Dimension, in. (mm)							NPT Thread	
T-Tube Size (in.)	P-NPT Size	Basic Ordering Number	L	Lx	D	B	Bx	F	E	Working Pressure psig (bar)	
1/4	1/4	SS-WLM-TS4-NS4	0.79 (20.1)	1.05 (26.7)	0.58 (14.7)	0.28 (7.1)	0.56 (14.2)	0.50 (12.7)	0.19 (4.8)	8000 (551)	
3/8	1/4	SS-WLM-TS6-NS4	1.04 (26.4)	1.05 (26.7)	0.58 (14.7)	0.31 (7.9)	0.56 (14.2)	0.50 (12.7)	0.28 (7.1)	8000 (551)	
3/8	3/8	SS-WLM-TS6-NS6	0.97 (24.6)	1.17 (29.7)	0.80 (20.2)	0.31 (7.9)	0.56 (14.2)	0.69 (17.5)	0.28 (7.1)	7800 (537)	
3/8	1/2	SS-WLM-TS6-NS8	1.02 (25.9)	1.45 (36.8)	0.94 (23.8)	0.31 (7.9)	0.75 (19.1)	0.81 (20.6)	0.28 (7.1)	7700 (530)	
1/2	1/2	SS-WLM-TS8-NS8	1.08 (27.4)	1.45 (36.8)	0.94 (23.8)	0.38 (9.7)	0.75 (19.1)	0.81 (20.6)	0.41 (10.4)	6600 (454)	
3/4	3/4	SS-WLM-TS12-NS12	1.53 (38.9)	1.56 (39.6)	1.04 (26.4)	0.44 (11.2)	0.75 (19.1)	1.06 (27.0)	0.62 (15.7)	5900 (406)	

Female Elbows

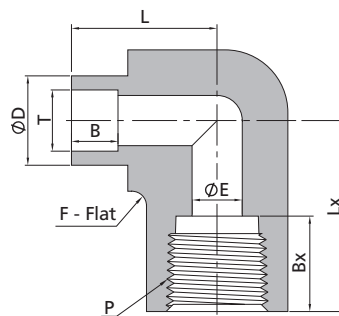

Fractional Tube			Dimension, in. (mm)							NPT Thread	
T-Tube Size (in.)	P-NPT Size	Basic Ordering Number	L	Lx	D	B	Bx	F	E	Working Pressure psig (bar)	
1/4	1/4	SS-WLF-TS4-NS4	0.90 (22.9)	1.17 (29.7)	0.80 (20.2)	0.28 (7.1)	0.59 (15.0)	0.69 (17.5)	0.19 (4.8)	7400 (509)	
3/8	1/4	SS-WLF-TS6-NS4	0.99 (25.1)	1.17 (29.7)	0.80 (20.2)	0.31 (7.9)	0.59 (15.0)	0.69 (17.5)	0.28 (7.1)	7400 (509)	
3/8	1/2	SS-WLF-TS6-NS8	1.13 (28.7)	1.56 (39.6)	1.15 (29.3)	0.31 (7.9)	0.78 (19.8)	1.00 (25.4)	0.28 (7.1)	5700 (392)	
1/2	1/2	SS-WLF-TS8-NS8	1.19 (30.2)	1.56 (39.6)	1.15 (29.3)	0.38 (9.7)	0.78 (19.8)	1.00 (25.4)	0.41 (10.4)	5700 (392)	

Unions

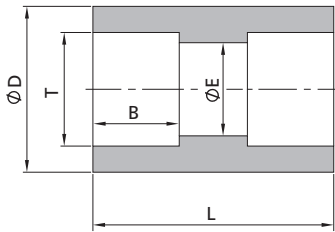

Fractional Tube						
T-Tube Size (in.)	Basic Ordering Number	Dimension, in. (mm)				Working Pressure psig (bar)
		L	D	B	E	
1/4	SS-WU-TS4	0.75 (19.1)	0.48 (12.2)	0.28 (7.1)	0.19 (4.8)	10700 (737)
3/8	SS-WU-TS6	0.88 (22.4)	0.60 (15.2)	0.31 (7.9)	0.28 (7.1)	8100 (558)
1/2	SS-WU-TS8	1.06 (26.9)	0.73 (18.5)	0.38 (9.7)	0.41 (10.4)	6600 (454)
5/8	SS-WU-TS10	1.19 (30.2)	0.92 (23.4)	0.41 (10.4)	0.50 (12.7)	6200 (427)
3/4	SS-WU-TS12	1.31 (33.3)	1.04 (26.4)	0.44 (11.2)	0.63 (16.0)	5900 (406)
7/8	SS-WU-TS14	1.40 (35.5)	1.24 (31.5)	0.50 (12.7)	0.74 (18.8)	5730 (395)
1	SS-WU-TS16	1.44 (36.6)	1.36 (34.5)	0.62 (15.7)	0.88 (22.4)	5600 (385)

Metric Tube						
T-Tube Size (mm)	Basic Ordering Number	Dimension, mm (in.)				Working Pressure psig (bar)
		L	D	B	E	
8	SS-WU-MTS8	22.4 (0.88)	14.3 (0.56)	7.9 (0.31)	6.4 (0.25)	9790 (675)
10	SS-WU-MTS10	23.6 (0.93)	16.5 (0.65)	7.9 (0.31)	7.4 (0.29)	8100 (558)
12	SS-WU-MTS12	26.9 (1.06)	20.2 (0.80)	9.7 (0.38)	9.5 (0.37)	6820 (470)
14	SS-WU-MTS14	28.0 (1.10)	23.8 (0.94)	10.0 (0.39)	10.4 (0.41)	6930 (478)
16	SS-WU-MTS16	30.2 (1.19)	23.8 (0.94)	10.4 (0.41)	12.7 (0.50)	6190 (426)
20	SS-WU-MTS20	28.0 (1.10)	27.0 (1.06)	11.2 (0.44)	17.0 (0.67)	5510 (380)

Reducing Unions

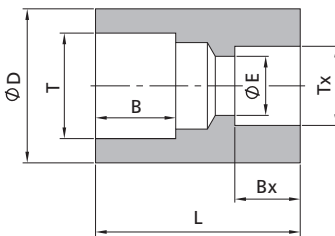

Fractional Tube			Fractional Tube					Working Pressure psig (bar)
T-Tube Size (in.)	Tx-Tube Size (in.)	Basic Ordering Number	Dimension, in. (mm)					
			L	D	B	E	Bx	
3/8	1/4	-WU-TS6-TS4	0.88 (22.4)	0.60 (15.2)	0.31 (7.9)	0.19 (4.8)	0.28 (7.1)	8100 (558)
1/2	1/4	-WU-TS8-TS4	0.96 (24.3)	0.73 (18.5)	0.38 (9.7)	0.19 (4.8)	0.28 (7.1)	6600 (454)
1/2	3/8	-WU-TS8-TS6	1.03 (26.1)	0.73 (18.5)	0.38 (9.7)	0.28 (7.1)	0.31 (7.9)	6600 (454)
3/4	3/8	-WU-TS12-TS6	1.17 (29.8)	1.04 (26.4)	0.44 (11.2)	0.28 (7.1)	0.31 (7.9)	5900 (406)
3/4	1/2	-WU-TS12-TS8	1.24 (31.6)	1.04 (26.4)	0.44 (11.2)	0.41 (10.4)	0.38 (9.7)	5900 (406)
1	3/4	-WU-TS16-TS12	1.26 (32.1)	1.36 (34.5)	0.62 (15.7)	0.63 (16.0)	0.44 (11.2)	5600 (385)

Metric Tube			Metric Tube					Working Pressure psig (bar)
T-Tube Size (mm)	Tx-Tube Size (mm)	Basic Ordering Number	Dimension, mm (in.)					
			L	D	B	E	Bx	
14	10	-WU-MTS14-MTS10	26.0 (1.02)	23.8 (0.94)	10.4 (0.41)	7.4 (0.29)	7.9 (0.31)	6930 (478)
25	14	-WU-MTS25-MTS14	30.0 (1.18)	34.5 (1.36)	15.7 (0.62)	10.4 (0.41)	10.0 (0.39)	5450 (376)
25	22	-WU-MTS25-MTS22	35.8 (1.41)	34.5 (1.36)	15.7 (0.62)	19.0 (0.75)	13.5 (0.53)	5450 (376)

Metric Tube			Fractional Tube					Working Pressure psig (bar)
T-Tube Size (mm)	Tx-Tube Size (in.)	Basic Ordering Number	Dimension, mm (in.)					
			L	D	B	E	Bx	
20	3/4	-WU-MTS20-TS12	28.0 (1.10)	27.0 (1.06)	11.2 (0.44)	15.7 (0.62)	11.2 (0.44)	5510 (380)
28	3/4	-WU-MTS28-TS12	36.8 (1.45)	40.0 (1.57)	20.0 (0.79)	15.7 (0.62)	11.2 (0.44)	5040 (348)

Fittings  
Valves and Filters  
Manifolds  
Tubing, Pipes, Hoses and Connectors  
Quick-connects, Vessels and Sample Cylinders  
Tubing Tools, Other Elements

Union Elbows

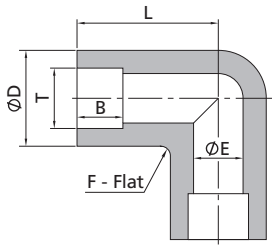

Fractional Tube		Dimension, in. (mm)					Working Pressure psig (bar)
T-Tube Size (in.)	Basic Ordering Number	L	D	B	F	E	
1/8	-WLU-TS2	0.59 (15.0)	0.43 (11.0)	0.10 (2.5)	0.37 (9.5)	0.09 (2.3)	12600 (863)
1/4	-WLU-TS4	0.86 (21.8)	0.50 (12.8)	0.28 (7.1)	0.44 (11.1)	0.19 (4.8)	10700 (737)
3/8	-WLU-TS6	1.04 (26.4)	0.65 (16.5)	0.31 (7.9)	0.56 (14.3)	0.28 (7.1)	8100 (558)
1/2	-WLU-TS8	1.17 (29.7)	0.80 (20.2)	0.38 (9.7)	0.69 (17.5)	0.41 (10.4)	6600 (454)
5/8	-WLU-TS10	1.42 (36.1)	0.94 (23.8)	0.41 (10.4)	0.81 (20.6)	0.50 (12.7)	6200 (427)
3/4	-WLU-TS12	1.56 (39.6)	1.15 (29.3)	0.44 (11.2)	1.00 (25.4)	0.63 (16.0)	5900 (406)
1	-WLU-TS16	1.92 (48.8)	1.44 (36.7)	0.62 (15.7)	1.25 (31.8)	0.88 (22.4)	5600 (385)

Metric Tube		Dimension, mm (in.)					Working Pressure psig (bar)
T-Tube Size (mm)	Basic Ordering Number	L	D	B	F	E	
10	-WLU-MTS10	24.6 (0.97)	16.5 (0.65)	7.9 (0.31)	14.3 (0.56)	7.4 (0.29)	8100 (558)
12	-WLU-MTS12	29.7 (1.17)	20.2 (0.80)	9.7 (0.38)	17.5 (0.69)	9.5 (0.37)	6820 (470)
14	-WLU-MTS14	31.7 (1.25)	23.8 (0.94)	10.0 (0.39)	20.6 (0.81)	10.4 (0.41)	6930 (478)
16	-WLU-MTS16	34.7 (1.37)	23.8 (0.94)	10.4 (0.41)	20.6 (0.81)	12.7 (0.50)	6190 (426)

Union 45° Elbows

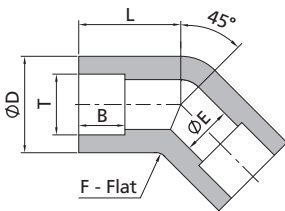

Fractional Tube		Dimension, in. (mm)					Working Pressure psig (bar)
T-Tube Size (in.)	Basic Ordering Number	L	D	B	F	E	
1/4	SS-WV-TS4	0.59 (15.0)	0.43 (11.0)	0.10 (2.5)	0.37 (9.5)	0.09 (2.3)	10700 (737)
3/8	SS-WV-TS6	0.78 (19.7)	0.50 (12.8)	0.28 (7.1)	0.44 (11.1)	0.19 (4.8)	8100 (558)
1/2	SS-WV-TS8	0.84 (21.3)	0.65 (16.5)	0.31 (7.9)	0.56 (14.3)	0.28 (7.1)	6600 (454)
3/4	SS-WV-TS12	1.13 (28.7)	0.80 (20.2)	0.38 (9.7)	0.69 (17.5)	0.41 (10.4)	5900 (406)
1	SS-WV-TS16	1.25 (31.8)	0.94 (23.8)	0.41 (10.4)	0.81 (20.6)	0.50 (12.7)	5600 (385)

Metric Tube		Dimension, mm (in.)					Working Pressure psig (bar)
T-Tube Size (mm)	Basic Ordering Number	L	D	B	F	E	
8	SS-WV-MTS8	17.3 (0.68)	14.7 (0.58)	7.9 (0.31)	12.7 (0.50)	6.4 (0.25)	9790 (675)
10	SS-WV-MTS10	19.1 (0.75)	16.5 (0.65)	7.9 (0.31)	14.3 (0.56)	7.4 (0.29)	8100 (558)
12	SS-WV-MTS12	21.3 (0.84)	20.2 (0.80)	9.7 (0.38)	17.5 (0.69)	9.5 (0.37)	6820 (470)
14	SS-WV-MTS14	26.4 (1.04)	23.8 (0.94)	10.0 (0.39)	20.6 (0.81)	10.4 (0.41)	6930 (478)
16	SS-WV-MTS16	26.4 (1.04)	23.8 (0.94)	10.4 (0.41)	20.6 (0.81)	12.7 (0.50)	6190 (426)
20	SS-WV-MTS20	28.7 (1.13)	29.3 (1.15)	11.2 (0.44)	25.4 (1.00)	17.0 (0.67)	5510 (380)
22	SS-WV-MTS22	29.7 (1.17)	31.2 (1.23)	13.5 (0.53)	27.0 (1.06)	19.0 (0.75)	6850 (472)
25	SS-WV-MTS25	31.8 (1.25)	36.7 (1.44)	15.7 (0.62)	31.8 (1.25)	22.0 (0.87)	5450 (376)

## Union Tees

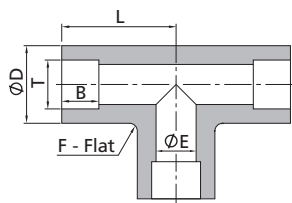

Fractional Tube							
T-Tube Size (in.)	Basic Ordering Number	Dimension, in. (mm)					Working Pressure psig (bar)
		L	D	B	F	E	
1/8	-WT-TS2	0.59 (15.0)	0.39 (10.0)	0.10 (2.5)	0.44 (11.1)	0.09 (2.3)	12600 (868)
1/4	-WT-TS4	0.86 (21.8)	0.50 (12.8)	0.28 (7.1)	0.44 (11.1)	0.19 (4.8)	10700 (737)
3/8	-WT-TS6	1.04 (26.4)	0.65 (16.5)	0.31 (7.9)	0.56 (14.3)	0.28 (7.1)	8100 (558)
1/2	-WT-TS8	1.17 (29.7)	0.80 (20.2)	0.38 (9.7)	0.69 (17.5)	0.41 (10.4)	6600 (454)
5/8	-WT-TS10	1.42 (36.1)	0.94 (23.8)	0.41 (10.4)	0.81 (20.6)	0.50 (12.7)	6200 (428)
3/4	-WT-TS12	1.56 (39.6)	1.15 (29.3)	0.44 (11.2)	1.00 (25.4)	0.63 (16.0)	5900 (406)
1	-WT-TS16	1.92 (48.8)	1.44 (36.7)	0.62 (15.7)	1.25 (31.8)	0.88 (22.4)	5600 (385)

Metric Tube							
T-Tube Size (mm)	Basic Ordering Number	Dimension, mm (in.)					Working Pressure psig (bar)
		L	D	B	F	E	
8	-WT-MTS8	19.8 (0.78)	14.7 (0.58)	7.9 (0.31)	12.7 (0.50)	6.4 (0.25)	9790 (675)
10	-WT-MTS10	24.6 (0.97)	16.5 (0.65)	7.9 (0.31)	14.3 (0.56)	7.4 (0.29)	8100 (558)
12	-WT-MTS12	29.7 (1.17)	20.2 (0.80)	9.7 (0.38)	17.5 (0.69)	9.5 (0.37)	6820 (470)
14	-WT-MTS14	31.7 (1.25)	23.8 (0.94)	10.0 (0.39)	20.6 (0.81)	10.4 (0.41)	6930 (478)
16	-WT-MTS16	36.0 (1.42)	23.8 (0.94)	10.4 (0.41)	20.6 (0.81)	12.7 (0.50)	6190 (426)
20	-WT-MTS20	39.6 (1.56)	29.3 (1.15)	11.2 (0.44)	25.4 (1.00)	17.0 (0.67)	5510 (380)
22	-WT-MTS22	41.3 (1.63)	31.2 (1.23)	13.5 (0.53)	27.0 (1.06)	19.0 (0.75)	6850 (472)
25	-WT-MTS25	48.8 (1.92)	36.7 (1.44)	15.7 (0.62)	31.8 (1.25)	22.0 (0.87)	5450 (376)

## Union Crosses

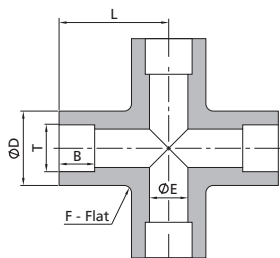

Fractional Tube							
T-Tube Size (in.)	Basic Ordering Number	Dimension, in. (mm)					Working Pressure psig (bar)
		L	D	B	F	E	
1/8	-WC-TS2	0.59 (15.0)	0.43 (11.0)	0.10 (2.5)	0.44 (11.1)	0.09 (2.3)	12600 (863)
1/4	-WC-TS4	0.86 (21.8)	0.50 (12.8)	0.28 (7.1)	0.44 (11.1)	0.19 (4.8)	10700 (737)
3/8	-WC-TS6	1.04 (26.4)	0.58 (14.7)	0.31 (7.9)	0.50 (12.7)	0.28 (7.1)	8100 (558)
1/2	-WC-TS8	1.17 (29.7)	0.80 (20.2)	0.38 (9.7)	0.69 (17.5)	0.41 (10.4)	6600 (454)
5/8	-WC-TS10	1.42 (36.1)	0.94 (23.8)	0.41 (10.4)	0.81 (20.6)	0.50 (12.7)	6200 (428)
3/4	-WC-TS12	1.56 (39.6)	1.15 (29.3)	0.44 (11.2)	1.00 (25.4)	0.63 (16.0)	5900 (406)
1	-WC-TS16	1.92 (48.8)	1.44 (36.7)	0.62 (15.7)	1.25 (31.8)	0.88 (22.4)	5600 (385)

Metric Tube							
T-Tube Size (mm)	Basic Ordering Number	Dimension, mm (in.)					Working Pressure psig (bar)
		L	D	B	F	E	
8	-WC-MTS8	19.8 (0.78)	14.7 (0.58)	7.9 (0.31)	12.7 (0.50)	6.4 (0.25)	9790 (675)
10	-WC-MTS10	24.6 (0.97)	16.5 (0.65)	7.9 (0.31)	14.3 (0.56)	7.1 (0.28)	8100 (558)
12	-WC-MTS12	29.7 (1.17)	20.2 (0.80)	9.7 (0.38)	17.5 (0.69)	9.5 (0.37)	6820 (470)
14	-WC-MTS14	31.7 (1.25)	23.8 (0.94)	10.0 (0.39)	20.6 (0.81)	10.4 (0.41)	6930 (478)
16	-WC-MTS16	36.0 (1.42)	23.8 (0.94)	10.4 (0.41)	20.6 (0.81)	12.7 (0.50)	6190 (426)
20	-WC-MTS20	39.6 (1.56)	29.3 (1.15)	11.2 (0.44)	25.4 (1.00)	17.0 (0.67)	5510 (380)
22	-WC-MTS22	41.3 (1.63)	31.2 (1.23)	13.5 (0.53)	27.0 (1.06)	19.0 (0.75)	6850 (472)
25	-WC-MTS25	48.8 (1.92)	36.7 (1.44)	15.7 (0.62)	31.8 (1.25)	22.0 (0.87)	5450 (376)

Fittings

Valves and Filters

Manifolds

Tubing, Pipes, Hoses and Connectors

Quick-connects, Vessels and Sample Cylinders

Tubing Tools, Other Elements

# Pipe Butt Weld Fittings

## Male Connectors

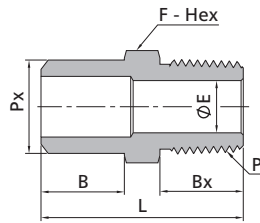

Pipe			Dimension, in. (mm)					NPT Thread	Working Pressure psig (bar)
Px-Sch80 Pipe Size	P-NPT Size	Basic Ordering Number	L	B	Bx	F	E		
1/4	1/4	-WM-PB4-NS4	1.35 (34.3)	0.56 (14.2)	0.56 (14.2)	0.56 (14.3)	0.28 (7.1)		8000 (551)
1/4	1/2	-WM-PB4-NS8	1.63 (41.3)	0.56 (14.2)	0.75 (19.1)	0.87 (22.2)	0.30 (7.7)		7700 (537)
3/8	1/4	-WM-PB6-NS4	1.37 (34.8)	0.56 (14.2)	0.56 (14.2)	0.69 (17.5)	0.28 (7.1)		6650 (459)
3/8	1/2	-WM-PB6-NS8	1.63 (41.3)	0.56 (14.2)	0.75 (19.1)	0.87 (22.2)	0.42 (10.7)		6650 (459)
1/2	1/4	-WM-PB8-NS4	1.63 (41.3)	0.75 (19.1)	0.56 (14.2)	0.87 (22.2)	0.28 (7.1)		6190 (427)
1/2	1/2	-WM-PB8-NS8	1.82 (46.2)	0.75 (19.1)	0.75 (19.1)	0.87 (22.2)	0.47 (11.9)		6190 (427)
3/4	1/4	-WM-PB12-NS4	1.69 (42.9)	0.75 (19.1)	0.56 (14.2)	1.06 (27.0)	0.28 (7.1)		5040 (348)
3/4	1/2	-WM-PB12-NS8	1.88 (47.8)	0.75 (19.1)	0.75 (19.1)	1.06 (27.0)	0.47 (11.9)		5040 (348)
1	1/4	-WM-PB16-NS4	1.97 (50.0)	0.94 (23.9)	0.56 (14.2)	1.37 (34.9)	0.28 (7.1)		4640 (320)
1	1/2	-WM-PB16-NS8	2.16 (54.9)	0.94 (23.9)	0.75 (19.1)	1.37 (34.9)	0.47 (11.9)		4640 (320)

## Female Connectors

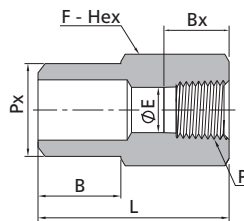

Pipe			Dimension, in. (mm)					NPT Thread	Working Pressure psig (bar)
Px-Sch80 Pipe Size	P-NPT Size	Basic Ordering Number	L	B	Bx	F	E		
1/4	1/2	-WF-PB4-NS8	1.53 (38.9)	0.56 (14.2)	0.78 (19.8)	1.06 (27.0)	0.30 (7.6)		4900 (337)
3/8	1/2	-WF-PB6-NS8	1.53 (38.9)	0.56 (14.2)	0.78 (19.8)	1.06 (27.0)	0.42 (10.7)		4900 (337)
1/2	1/4	-WF-PB8-NS4	1.47 (37.3)	0.75 (19.1)	0.59 (15.0)	0.87 (22.2)	0.41 (10.4)		7500 (516)
1/2	1/2	-WF-PB8-NS8	1.72 (43.7)	0.75 (19.1)	0.78 (19.8)	1.06 (27.0)	0.55 (13.9)		4900 (337)

# Pipe Socket Weld Fittings

## Male Connectors

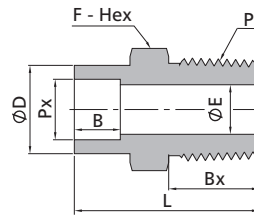

Pipe			Dimension, in. (mm)							NPT Thread	Working Pressure psig (bar)
Px-Pipe Size	P-NPT Size	Basic Ordering Number	L	D	B	Bx	F	E			
1/4	1/4	-WM-PS4-NS4	1.39 (35.2)	0.88 (22.4)	0.39 (9.9)	0.56 (14.2)	0.94 (23.8)	0.28 (7.1)	8000 (551)		
1/4	1/2	-WM-PS4-NS8	1.57 (40.0)	0.88 (22.4)	0.39 (9.9)	0.75 (19.1)	0.94 (23.8)	0.36 (9.1)	7700 (530)		
3/8	3/8	-WM-PS6-NS6	1.50 (38.0)	1.03 (26.2)	0.39 (9.9)	0.56 (14.2)	1.06 (27.0)	0.38 (9.7)	7100 (489)		
3/8	1/2	-WM-PS6-NS8	1.69 (42.9)	1.03 (26.2)	0.39 (9.9)	0.75 (19.1)	1.06 (27.0)	0.47 (11.9)	7100 (489)		
1/2	3/8	-WM-PS8-NS6	1.59 (40.3)	1.25 (31.8)	0.39 (9.9)	0.56 (14.2)	1.31 (33.3)	0.38 (9.7)	6800 (468)		
1/2	1/2	-WM-PS8-NS8	1.78 (45.2)	1.25 (31.8)	0.39 (9.9)	0.75 (19.1)	1.31 (33.3)	0.47 (11.9)	6800 (468)		
3/4	1/2	-WM-PS12-NS8	2.14 (54.3)	1.47 (37.3)	0.51 (13.0)	0.75 (19.1)	1.50 (38.1)	0.47 (11.9)	5800 (399)		
3/4	3/4	-WM-PS12-NS12	2.14 (54.3)	1.47 (37.3)	0.51 (13.0)	0.75 (19.1)	1.50 (38.1)	0.62 (15.7)	5800 (399)		
1	3/4	-WM-PS16-NS12	2.20 (55.8)	1.86 (47.2)	0.51 (13.0)	0.75 (19.1)	1.87 (47.6)	0.62 (15.7)	6100 (420)		
1	1	-WM-PS16-NS16	2.39 (60.6)	1.86 (47.2)	0.51 (13.0)	0.94 (23.9)	1.87 (47.6)	0.88 (22.4)	5300 (365)		

## Female Connectors

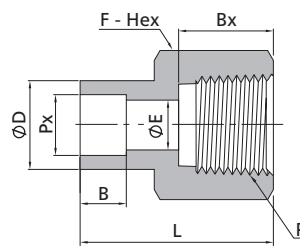

Pipe			Dimension, in. (mm)							NPT Thread	Working Pressure psig (bar)
Px-Pipe Size	P-NPT Size	Basic Ordering Number	L	D	B	Bx	F	E			
1/4	1/4	-WF-PS4-NS4	1.32 (33.5)	0.88 (22.4)	0.39 (9.9)	0.59 (15.0)	0.94 (23.8)	0.36 (9.1)	8000 (551)		
1/4	3/8	-WF-PS4-NS6	1.32 (33.5)	0.88 (22.4)	0.39 (9.9)	0.59 (15.0)	0.94 (23.8)	0.36 (9.1)	6790 (463)		
3/8	3/8	-WF-PS6-NS6	1.34 (34.1)	1.03 (26.2)	0.39 (9.9)	0.59 (15.0)	1.06 (27.0)	0.49 (12.4)	7100 (489)		
3/8	1/2	-WF-PS6-NS8	1.54 (39.1)	1.03 (26.2)	0.39 (9.9)	0.78 (19.8)	1.06 (27.0)	0.49 (12.4)	4900 (337)		
1/2	1/2	-WF-PS8-NS8	1.57 (40.0)	1.25 (31.8)	0.39 (9.9)	0.78 (19.8)	1.31 (33.3)	0.62 (15.7)	6800 (468)		
1/2	3/4	-WF-PS8-NS12	1.60 (40.6)	1.25 (31.8)	0.39 (9.9)	0.81 (20.6)	1.31 (33.3)	0.62 (15.7)	4600 (316)		
3/4	3/4	-WF-PS12-NS12	2.09 (53.2)	1.47 (37.3)	0.51 (13.0)	0.81 (20.6)	1.50 (38.1)	0.82 (20.8)	5800 (399)		
3/4	1	-WF-PS12-NS16	2.29 (58.1)	1.47 (37.3)	0.51 (13.0)	1.00 (25.4)	1.63 (41.3)	0.82 (20.8)	4400 (303)		

Unions

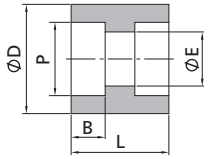

Pipe		Dimension, in. (mm)				Working Pressure psig (bar)
P-Pipe Size	Basic Ordering Number	L	D	B	E	
1/8	-WU-PS2	1.01 (25.7)	0.67 (17.1)	0.39 (9.9)	0.28 (7.0)	8230 (568)
1/4	-WU-PS4	1.06 (26.9)	0.88 (22.4)	0.39 (9.9)	0.38 (9.7)	8000 (551)
3/8	-WU-PS6	1.12 (28.4)	1.03 (26.2)	0.39 (9.9)	0.49 (12.4)	7100 (489)
1/2	-WU-PS8	1.16 (29.5)	1.25 (31.8)	0.39 (9.9)	0.62 (15.7)	6800 (468)
3/4	-WU-PS12	1.75 (44.5)	1.47 (37.3)	0.51 (13.0)	0.82 (20.8)	5800 (399)
1	-WU-PS16	1.75 (44.5)	1.86 (47.2)	0.51 (13.0)	1.05 (26.7)	6100 (420)

Weld Adapters

Tube Butt Weld to Tube Socket Weld

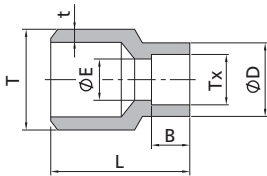

Fractional Tube								
T-Tube O.D. (in.)	t-Wall Thickness (in.)	Tx-Tube Size (in.)	Basic Ordering Number	Dimension, in. (mm)				Working Pressure psig (bar)
				L	B	D	E	
1/4	0.083	1/8	-WA-TB4-TS2	0.56 (14.2)	0.10 (2.5)	0.31 (8.0)	0.09 (2.3)	12600 (868)
3/8	0.095	1/4	-WA-TB6-TS4	0.75 (19.1)	0.28 (7.1)	0.48 (12.2)	0.19 (4.8)	8200 (564)
1/2	0.095	1/4	-WA-TB8-TS4	0.88 (22.4)	0.28 (7.1)	0.50 (12.7)	0.19 (4.8)	7500 (516)
1/2	0.095	3/8	-WA-TB8-TS6	0.88 (22.4)	0.31 (7.9)	0.60 (15.2)	0.28 (7.1)	7500 (516)
3/4	0.120	1/2	-WA-TB12-TS8	1.12 (28.4)	0.38 (9.7)	0.73 (18.5)	0.41 (10.4)	6300 (434)
1	0.134	1/2	-WA-TB16-TS8	1.38 (35.1)	0.38 (9.7)	0.73 (18.5)	0.41 (10.4)	5300 (365)
1	0.134	3/4	-WA-TB16-TS12	1.50 (38.1)	0.44 (11.2)	1.04 (26.4)	0.63 (16.0)	5300 (365)

Pipe Butt Weld to Tube Socket Weld

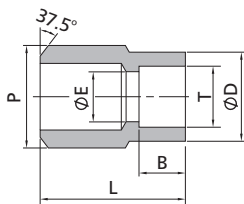

Pipe			Fractional Tube				Working Pressure psig (bar)
P-Sch80 Pipe Size	T-Tube Size (in.)	Basic Ordering Number	Dimension, in. (mm)				
			L	B	D	E	
1/4	1/4	-WA-PB4-TS4	0.88 (22.4)	0.28 (7.1)	0.48 (12.2)	0.19 (4.8)	10810 (744)
3/8	1/4	-WA-PB6-TS4	1.03 (26.2)	0.31 (7.9)	0.48 (12.2)	0.19 (4.8)	8500 (586)
3/8	3/8	-WA-PB6-TS6	1.03 (26.2)	0.31 (7.9)	0.60 (15.2)	0.28 (7.1)	8500 (586)
3/8	1/2	-WA-PB6-TS8	1.00 (25.4)	0.38 (9.7)	0.73 (18.5)	0.41 (10.4)	6930 (476)
1/2	1/4	-WA-PB8-TS4	1.12 (28.4)	0.28 (7.1)	0.48 (12.2)	0.19 (4.8)	8190 (563)
1/2	3/8	-WA-PB8-TS6	1.12 (28.4)	0.31 (7.9)	0.60 (15.2)	0.28 (7.1)	8190 (563)
1/2	1/2	-WA-PB8-TS8	1.19 (30.2)	0.38 (9.7)	0.73 (18.5)	0.41 (10.4)	6930 (476)
3/4	1/4	-WA-PB12-TS4	1.50 (38.1)	0.28 (7.1)	0.48 (12.2)	0.19 (4.8)	6930 (476)
3/4	3/8	-WA-PB12-TS6	1.50 (38.1)	0.31 (7.9)	0.60 (15.2)	0.28 (7.1)	6930 (476)
3/4	1/2	-WA-PB12-TS8	1.50 (38.1)	0.38 (9.7)	0.73 (18.5)	0.41 (10.4)	6930 (476)
3/4	3/4	-WA-PB12-TS12	1.50 (38.1)	0.44 (11.2)	1.04 (26.4)	0.63 (16.0)	6190 (483)
1	3/8	-WA-PB16-TS6	1.38 (35.1)	0.31 (7.9)	0.60 (15.2)	0.28 (7.1)	6300 (434)
1	1/2	-WA-PB16-TS8	1.56 (39.6)	0.38 (9.7)	0.73 (18.5)	0.41 (10.4)	6300 (434)

# Pipe to Weld Fittings

## Pipe to Tube Butt Weld

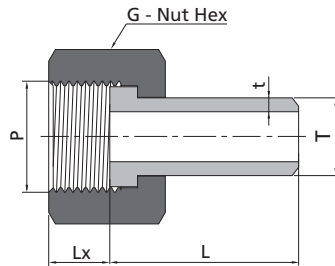

ISO Parallel Thread				Metric Tube			
P-ISO Thread Size	T-Tube O.D. (mm)	t-Wall Thickness (mm)	Basic Ordering Number	Dimension, mm (in.)			Working Pressure psig (bar)
				L	G	Lx	
1/2	12	2.2	-PUW-RG8-MTB12	34.0 (1.34)	27.0 (1.06)	11.0 (0.43)	6470 (446)
1/2	14	2.5	-PUW-RG8-MTB14	34.0 (1.34)	27.0 (1.06)	11.0 (0.43)	6280 (433)
1/2	16	2.8	-PUW-RG8-MTB16	34.0 (1.34)	27.0 (1.06)	11.0 (0.43)	6140 (423)

Metric Thread				Metric Tube			
P-Metric Thread Size	T-Tube O.D. (mm)	t-Wall Thickness (mm)	Basic Ordering Number	Dimension, mm (in.)			Working Pressure psig (bar)
				L	G	Lx	
M12 x 1.5	6	1.8	-PUW-MS12-MTB6	25.0 (0.98)	16.0 (0.63)	9.0 (0.35)	12660 (873)
M12 x 1.5	8	1.8	-PUW-MS12-MTB8	30.0 (1.18)	16.0 (0.63)	9.0 (0.35)	8320 (574)
M14 x 1.5	8	1.8	-PUW-MS14-MTB8	30.0 (1.18)	18.0 (0.71)	9.0 (0.35)	8320 (574)
M14 x 1.5	10	2.2	-PUW-MS14-MTB10	30.0 (1.18)	18.0 (0.71)	9.0 (0.35)	8160 (563)
M16 x 1.5	8	1.8	-PUW-MS16-MTB8	30.0 (1.18)	22.0 (0.87)	9.0 (0.35)	8320 (574)
M16 x 1.5	10	2.2	-PUW-MS16-MTB10	30.0 (1.18)	22.0 (0.87)	9.0 (0.35)	8160 (563)
M16 x 1.5	12	2.2	-PUW-MS16-MTB12	34.0 (1.34)	22.0 (0.87)	9.0 (0.35)	6470 (446)
M18 x 1.5	10	2.2	-PUW-MS18-MTB10	34.0 (1.34)	22.0 (0.87)	10.0 (0.39)	8160 (563)
M18 x 1.5	12	2.2	-PUW-MS18-MTB12	34.0 (1.34)	22.0 (0.87)	10.0 (0.39)	6470 (446)
M18 x 1.5	14	2.5	-PUW-MS18-MTB14	34.0 (1.34)	22.0 (0.87)	10.0 (0.39)	6280 (433)
M20 x 1.5	10	2.2	-PUW-MS20-MTB10	34.0 (1.34)	25.0 (0.98)	11.0 (0.43)	8160 (563)
M20 x 1.5	12	2.2	-PUW-MS20-MTB12	34.0 (1.34)	25.0 (0.98)	11.0 (0.43)	6470 (446)
M20 x 1.5	14	2.5	-PUW-MS20-MTB14	34.0 (1.34)	25.0 (0.98)	11.0 (0.43)	6280 (433)
M20 x 1.5	15	2.5	-PUW-MS20-MTB15	34.0 (1.34)	25.0 (0.98)	11.0 (0.43)	6160 (425)
M20 x 1.5	16	2.8	-PUW-MS20-MTB16	34.0 (1.34)	25.0 (0.98)	11.0 (0.43)	6140 (423)
M22 x 1.5	14	2.5	-PUW-MS22-MTB14	34.0 (1.34)	27.0 (1.06)	11.0 (0.43)	6280 (433)
M22 x 1.5	16	2.8	-PUW-MS22-MTB16	34.0 (1.34)	27.0 (1.06)	11.0 (0.43)	6140 (423)
M24 x 1.5	16	2.8	-PUW-MS24-MTB16	34.0 (1.34)	30.0 (1.18)	11.0 (0.43)	6140 (423)
M24 x 1.5	18	2.8	-PUW-MS24-MTB18	34.0 (1.34)	30.0 (1.18)	11.0 (0.43)	5670 (392)
M24 x 1.5	20	3.0	-PUW-MS24-MTB20	34.0 (1.34)	30.0 (1.18)	11.0 (0.43)	5110 (352)
M27 x 2	14	2.5	-PUW-MS27-MTB14	34.0 (1.34)	32.0 (1.26)	14.0 (0.55)	6280 (433)
M27 x 2	16	2.8	-PUW-MS27-MTB16	34.0 (1.34)	32.0 (1.26)	14.0 (0.55)	6140 (423)
M27 x 2	18	2.8	-PUW-MS27-MTB18	34.0 (1.34)	32.0 (1.26)	14.0 (0.55)	5670 (392)
M27 x 2	20	3.0	-PUW-MS27-MTB20	40.0 (1.57)	32.0 (1.26)	14.0 (0.55)	5110 (352)
M27 x 2	22	3.0	-PUW-MS27-MTB22	40.0 (1.57)	32.0 (1.26)	14.0 (0.55)	4620 (319)
M30 x 2	22	3.0	-PUW-MS30-MTB22	40.0 (1.57)	35.0 (1.38)	18.0 (0.71)	4620 (319)
M30 x 2	25	3.5	-PUW-MS30-MTB25	45.0 (1.77)	35.0 (1.38)	18.0 (0.71)	4730 (326)
M33 x 2	28	4.0	-PUW-MS33-MTB28	45.0 (1.77)	41.0 (1.61)	18.0 (0.71)	5160 (356)
M36 x 2	30	4.0	-PUW-MS36-MTB30	45.0 (1.77)	41.0 (1.61)	18.0 (0.71)	4760 (328)

Fittings

Valves and Filters

Manifolds

Tubing, Pipes, Hoses  
and ConnectorsQuick-connects, Vessels  
and Sample CylindersTubing Tools,  
Other Elements



Male Pipe to Tube Butt Weld

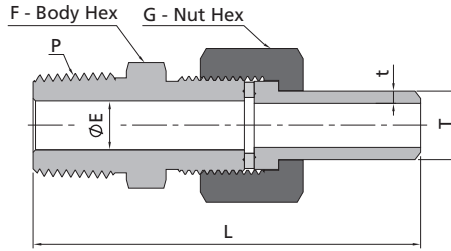

NPT Thread				Metric Tube				
P-NPT Size	T-Tube O.D. (mm)	t-Wall Thickness (mm)	Basic Ordering Number	Dimension, mm (in.)				Working Pressure psig (bar)
				L	F	G	E	
1/8	14	2.5	-MUW-NS2-MTB14	69.0 (2.72)	19.0 (0.75)	22.0 (0.87)	4.8 (0.19)	6280 (433)
1/4	6	1.8	-MUW-NS4-MTB6	60.0 (2.36)	14.0 (0.55)	14.0 (0.55)	3.0 (0.12)	8240 (566)
1/4	8	1.8	-MUW-NS4-MTB8	73.2 (2.88)	14.0 (0.55)	16.0 (0.63)	4.0 (0.16)	8240 (566)
1/4	10	2.2	-MUW-NS4-MTB10	73.2 (2.88)	15.0 (0.59)	18.0 (0.71)	6.0 (0.24)	8160 (563)
1/4	12	2.2	-MUW-NS4-MTB12	73.2 (2.88)	18.0 (0.71)	22.0 (0.87)	7.0 (0.28)	6470 (446)
1/4	14	2.5	-MUW-NS4-MTB14	73.2 (2.88)	19.0 (0.75)	22.0 (0.87)	7.1 (0.28)	6280 (433)
1/4	16	2.8	-MUW-NS4-MTB16	73.2 (2.88)	22.0 (0.87)	25.0 (0.98)	7.1 (0.28)	6140 (423)
1/4	18	2.8	-MUW-NS4-MTB18	74.2 (2.92)	24.0 (0.94)	27.0 (1.06)	7.1 (0.28)	5670 (392)
3/8	14	2.5	-MUW-NS6-MTB14	73.2 (2.88)	19.0 (0.75)	22.0 (0.87)	9.7 (0.38)	6280 (433)
1/2	12	2.2	-MUW-NS8-MTB12	78.0 (3.07)	18.0 (0.71)	22.0 (0.87)	7.0 (0.28)	6470 (446)
1/2	14	2.5	-MUW-NS8-MTB14	78.0 (3.07)	19.0 (0.75)	22.0 (0.87)	9.0 (0.35)	6280 (433)
1/2	16	2.8	-MUW-NS8-MTB16	78.0 (3.07)	22.0 (0.87)	25.0 (0.98)	10.0 (0.39)	6140 (423)
1/2	22	3.0	-MUW-NS8-MTB22	82.0 (3.23)	30.0 (1.18)	32.0 (1.26)	11.9 (0.47)	4620 (319)
1/2	25	2.8	-MUW-NS8-MTB25	86.0 (3.39)	32.0 (1.26)	35.0 (1.38)	11.9 (0.47)	4730 (326)
1	25	3.5	-MUW-NS16-MTB25	103.0 (4.06)	35.0 (1.38)	35.0 (1.38)	17.0 (0.67)	4730 (326)

# Part Number Description

SS - WLM - TS6 - NS6 - □ - □ - □ - □ - □ - □

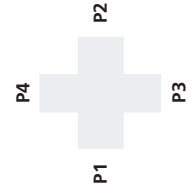
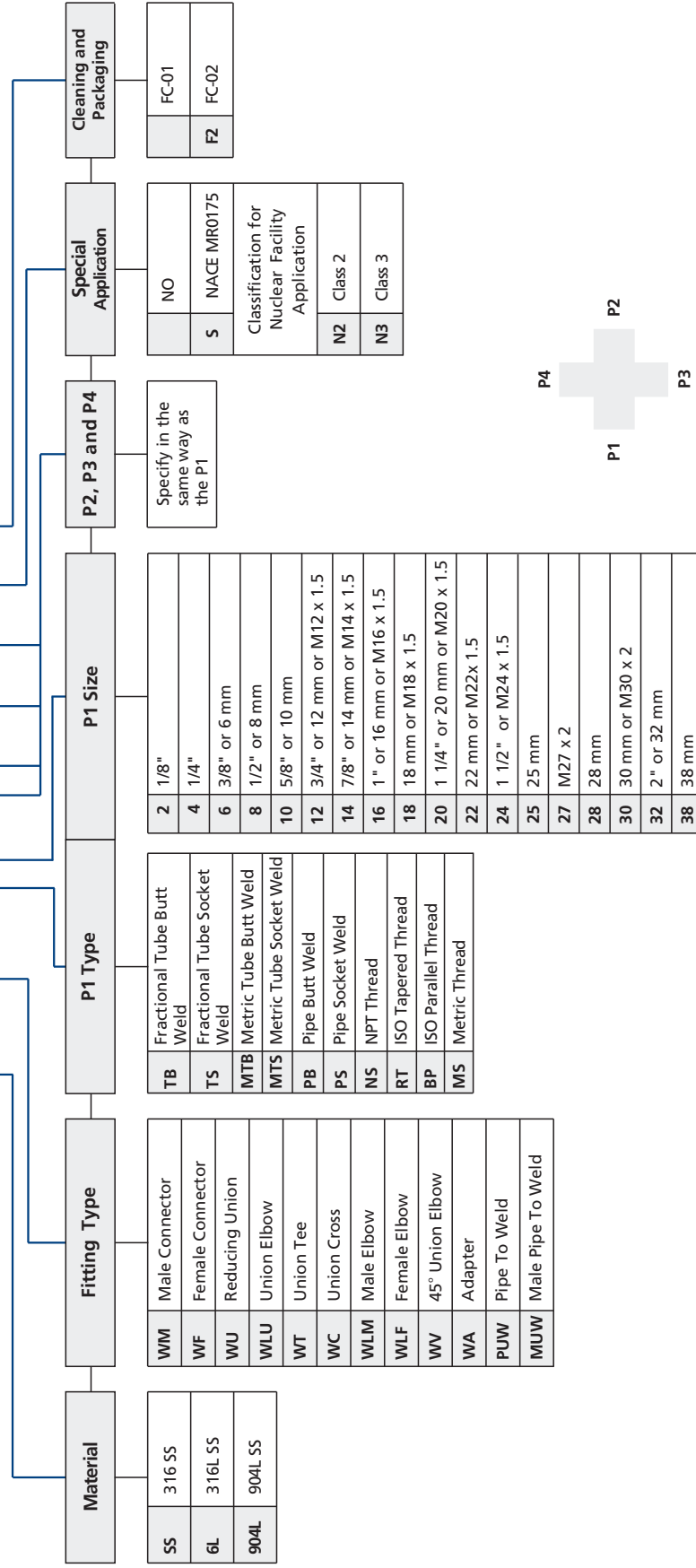

- P1, P2, P3 and P4 shall be described in the following orders:
- Pipe thread connection type after weld connection type ("PUW" and "MUW" excluded)
  - Pipe Butt Weld - Tube Butt Weld - Pipe Socket Weld - Tube Socket Weld - Others
  - Describe in descending order as per size if the end connection types are the same
  - Describe the end of P1 if all end connections are the same

**Cleaning and Packaging:**

- FC-01: Standard cleaning and packaging for general industrial procedures
- FC-02: Special cleaning and packaging for wetted system components to ensure compliance with product cleanliness requirement as stated in ASTM G93 Level C

Note: "Part Number Description" is used for composition rules of FITOK product model, Not suitable for specific product part number selection, not random combinations. If in doubt, please contact FITOK group or authorized agent.

Tubing Tools, Other Elements	Quick-connects, Vessels and Sample Cylinders	Tubing, Pipes, Hoses and Connectors	Manifolds	Valves and Filters	Fittings
------------------------------	--	-------------------------------------	-----------	--------------------	----------