

High performance liquid-solids separation systems

JPL

Exclusive internal acceleration creates maximum performance to achieve maximum protection of fluid handling systems from unwanted solids (see illustration inside for details). Its advanced & patented design, building upon the performance LAKOS is known for, now also removes 50% more of the finer solids (< 40 microns), resulting in higher aggregate solids removal. Independently tested. Proven superior for today's demanding filtration requirements. For settleable solids only.

Trouble-free operation & advanced purging/solids-handling concepts keep fluids clean and concentrate separated solids

No screens or filter elements to clean or replace; no messy servicing routines

No backwashing; zero fluid loss options

Low & steady pressure loss

Choice of profiles to accommodate space/piping limitations

Swirlex internal accelerating slots for optimum solids-removal performance; patented

Vortube for enhanced solids separation/collection; patented

Grooved inlet/outlet connections for easy installation; optional flanged connections also available

In-line inlet/outlet configuration for simplified piping (low-profile models only)

Unishell construction for easy installation

Optional material construction & ASME code



Flow range:
4 - 12,750 U.S. gpm
(1 - 2895 m³/hr) per unit

Maximum standard
pressure rating:
150 psi (10.3 bar)



JPL Series includes inlet/outlet pressure gauges with petcock valves and a manual isolation valve for the purge outlet.



Also available with weld-on flanges. See page 3 for other details.

How-it-Works Illustration

Model Specifications

Installation & Operating Instructions

Maintenance & Purging

Engineering Specifications

How It Works

Automatic Purging

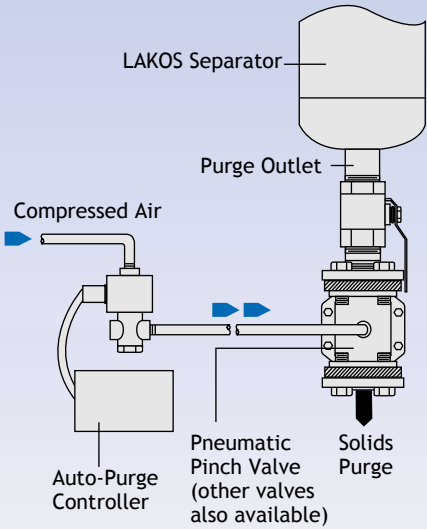

Solids Handling Options

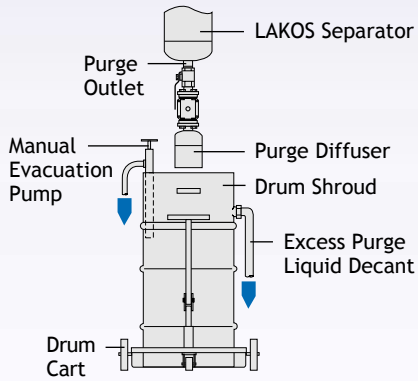

Systems also available with a tilt-style hopper.

LAKOS products are manufactured and sold under one or more of the following U.S. Patents: 3,289,608; 3,512,651; 3,568,837; 3,701,425; 3,947,364; 3,963,073; 4,027,481; 4,120,795; 4,123,800; 4,140,638; 4,147,630; 4,148,735; 4,305,825; 4,555,333; 5,320,747; 5,338,341; 5,368,735; 5,425,876; 5,571,416; 5,578,203; 5,622,545; 5,653,874; 5,894,995; Des. 327,693 and corresponding foreign patents. Other U.S. and foreign patents pending.

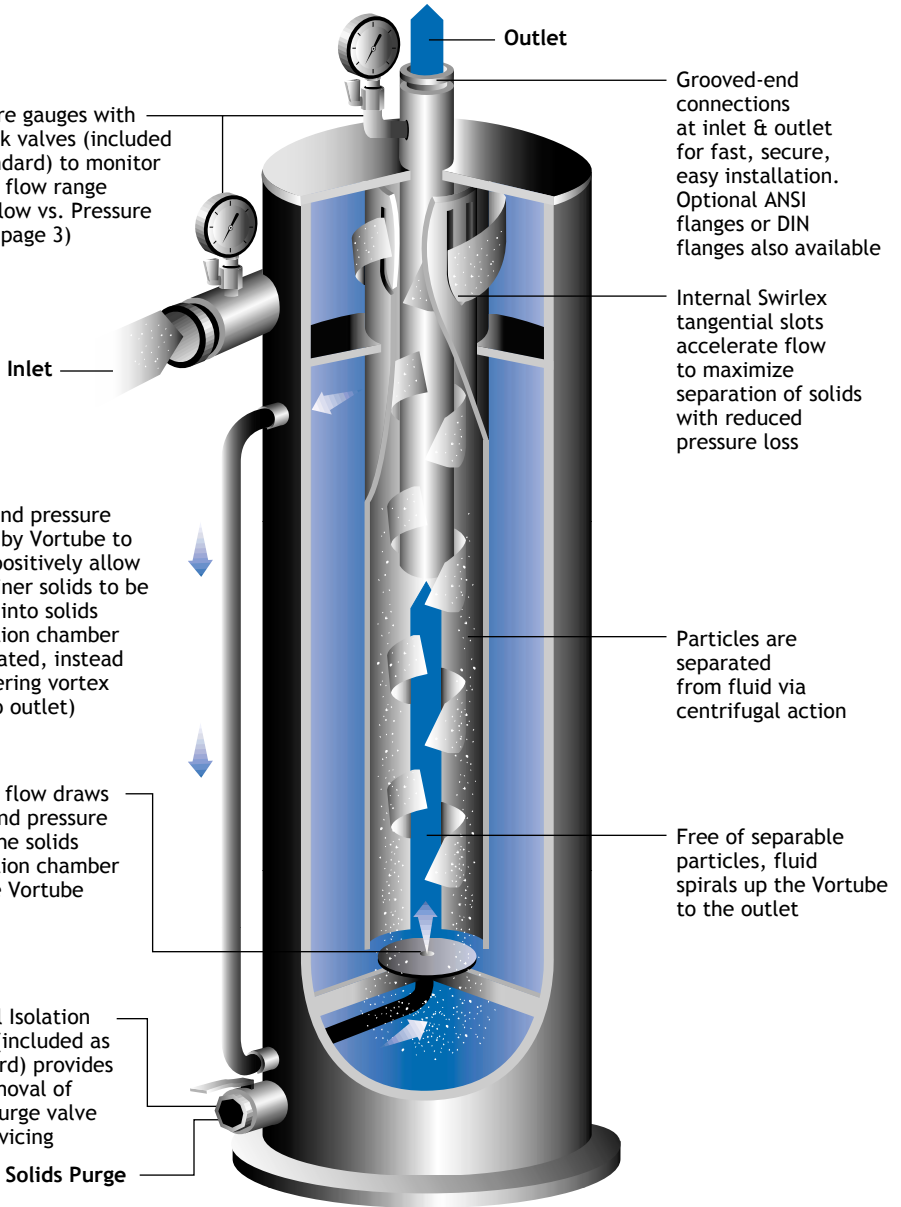

Performance

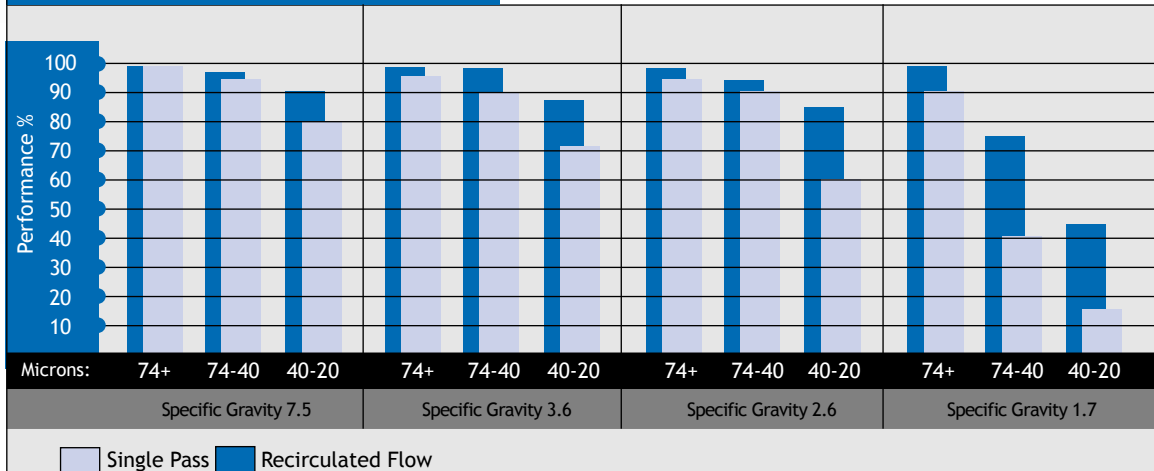

Specifications

Model*	Flow Range		Inlet/Outlet Grooved Coupling**	Purge Size Male N.P.T.	Collection Chamber Capacity		Weight		Weight with Water	
	U.S. gpm	m ³ /hr			gal	liters	lbs.	kg	lbs	kg
JPL-0004	4-10	1-2.5	1/2" NPT**	2"	0.09	0.3	17	8	20	9
JPL-0010	10-20	2.5-4.5	3/4" NPT**	2"	0.11	0.4	25	11	31	14
JPL-0016	16-30	4-7	1"	2"	0.15	0.6	36	16	47	21
JPL-0028	28-45	7-10	1-1/4"	2"	0.27	1.0	53	24	71	32
JPL-0038	38-65	9-15	1-1/2"	2"	0.4	1.5	78	35	108	49
JPL-0060	60-100	14-23	2"	2"	0.8	3.0	138	63	209	95
JPL-0085	85-145	19-33	2-1/2"	2"	0.8	3.0	182	83	266	121
JPL-0130	130-225	30-51	3"	2"	0.8	3.0	190	86	278	126
JPL-0200	200-325	45-74	4"	2"	1.6	6.1	302	137	482	219
JPL-0285-L JPL-0285-V	285-525	65-120	4"	2"	2.1 5.4	7.9 20.5	482 446	219 203	792 730	360 332
JPL-0450-L JPL-0450-V	450-825	102-190	6"	2"	2.8 6.7	10.6 25.4	705 664	321 302	1169 1099	531 500
JPL-0650-L JPL-0650-V	650-1200	150-275	6"	2"	4.3 10.4	16.3 39.4	888 857	404 390	1586 1513	721 688
JPL-1160-L JPL-1160-V	1160-2150	265-490	8"	2"	8.6 20.5	32.6 77.6	1324 1344	602 611	2649 2598	1204 1181
JPL-1850-L JPL-1850-V	1850-3400	420-775	10"	2"	15.0 31.5	56.8 119.2	1777 1861	808 846	3919 3875	1781 1761
JPL-2650-L JPL-2650-V	2650-4900	600-1115	12"	2"	23.5 51.1	89.0 193.4	2092 3079	1319 1340	6094 6112	2770 2778
JPL-4200-L JPL-4200-V	4200-7800	950-1775	16"	3"	52.2 99.3	197.6 375.9	4824 5324	2193 2420	11541 11694	5246 5316
JPL-6700-L JPL-6700-V	6700-12750	1520-2895	20"	3"	81.0 162.3	306.6 614.4	7408 8127	3367 3694	18260 18455	8300 8389

* Models ending with "L" are low profile, "V" for vertical profile

** Inlet/Outlet may also be specified with ANSI flanges or DIN flanges; JPL-0004 and JPL-0010 are standard male, N.P.T. (BSP or JIS threads available); other models also available with optional threading

Maximum pressure rating: 150 psi (10.3 bar); consult factory for higher pressure requirements

Pressure loss range: 3 - 12 psi (.2 - .8 bar)

Maximum particle size: JPL-0016 and smaller - .25 inch (6 mm); all other models - .375 inch (9 mm)

Material (standard carbon steel): Domes - A 285C/516 GR70, .25 inch (6 mm) minimum thickness

Other parts - A-36, A-53B or other quality grade, .25 inch (6 mm) minimum thickness; special coatings and other materials available - consult factory

Paint coating: Acrylic urethane, spray-on royal blue

Flow vs. Pressure Loss

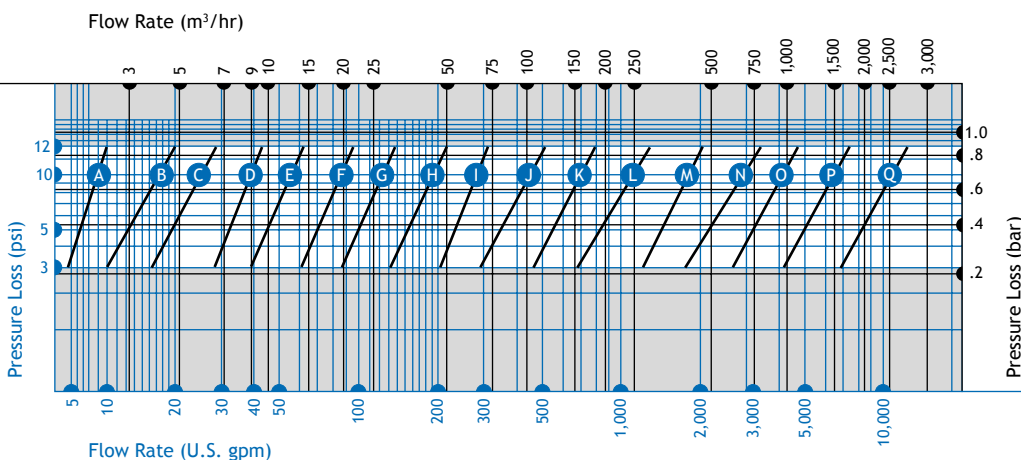

- A JPL-0004
- B JPL-0010
- C JPL-0016
- D JPL-0028
- E JPL-0038
- F JPL-0060
- G JPL-0085
- H JPL-0130
- I JPL-0200
- J JPL-0285
- K JPL-0450
- L JPL-0650
- M JPL-1160
- N JPL-1850
- O JPL-2650
- P JPL-4200
- Q JPL-6700

Installation Instructions

Maintenance/Purging

1. LAKOS JPL Separators must be purged regularly to remove the separated solids from the temporary collection chamber.
2. All purge hardware should be installed prior to any elbows or turns in the purge piping. Avoid "uphill" purging, which can clog purge piping and hinder effective solids evacuation.
3. For best results, purging is recommended while the LAKOS Separator is in operation, utilizing system pressure to enhance solids evacuation.
4. LAKOS provides a full selection of rugged, durable automatic purging and solids-handling systems to optimize the performance of your separation system. **CAUTION:** Economy-type valves typically fail prematurely in the harsh/abrasive environment of solids purging.
5. Be sure to install the manual isolation valve (provided as standard) prior to the automatic valve (available from LAKOS at additional cost) in order to facilitate servicing of the automatic valve without system shutdown.

- 1 LAKOS JPL Separators are shipped on skids or in wooden crates. Support legs (when applicable) are detached for shipping. A large ring, located on the unit's side or upper chamber, is provided for hoisting as necessary.
- 2 A suitable foundation is necessary to accommodate the LAKOS Separator's weight including liquid (see data, page 3). Anchor bolts are recommended in the base of the legs (low profile) or skirt (vertical profile).
- 3 Prior to installation, inspect the inlet/outlet/purge connections for foreign objects incurred during shipping/storage.
- 4 Inlet/outlet pipe connections to the LAKOS Separator should be a straight run of at least five pipe diameters to minimize turbulence and enhance performance.
- 5 Proper purge hardware and/or solids-handling equipment is required to flush separated solids from the separator (see details, page 2).
- 6 All LAKOS Separators operate within a prescribed flow range (see data, page 3). Pipe size is not a factor in model selection. Use appropriate hardware to match the inlet/outlet size. Grooved couplings are not included with the separator. Optional flanged connections are available upon request.
- 7 Inlet pressure to the LAKOS Separator must be at least equal to or greater than the anticipated pressure loss through the separator (see pressure loss chart, page 3) plus 15 psi (1 bar) plus whatever downstream pressure is required.
- 8 Pressure gauges (provided as standard, with petcock valves) are required at both the inlet and outlet of the separator in order to monitor pressure loss and proper system flow (see "Flow vs. Pressure Loss" chart, page 3). If separator operates with an open discharge, a valve should be installed to create a back pressure of at least 5 psi (.3 bar).
- 9 Winterizing is important if the LAKOS Separator is to remain idle in freezing temperatures. Drain liquid as necessary to avoid expansion of water to ice and related damages.

Low Flow Rates

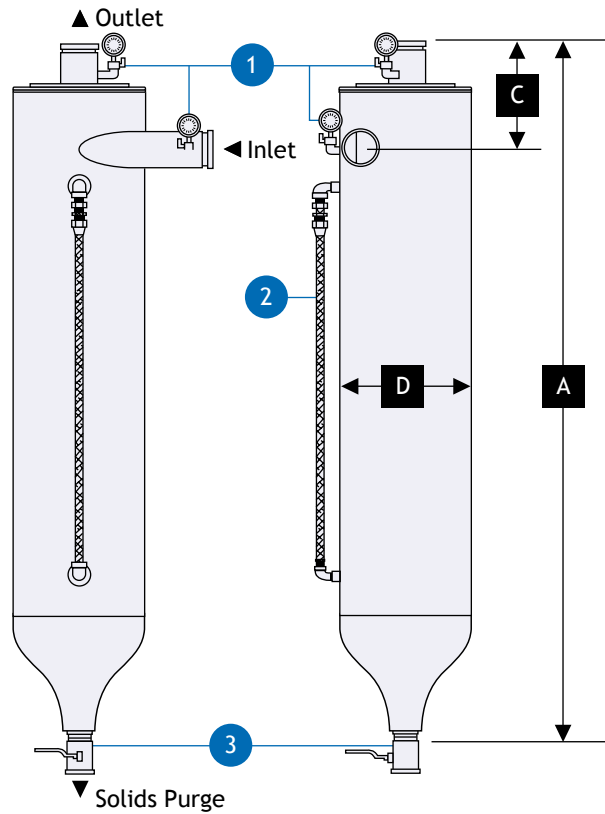

Top View

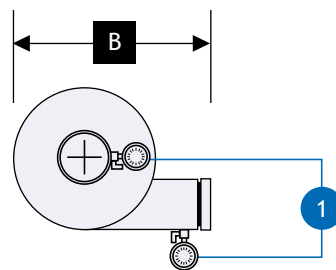

Dimensions

Model	A		B		C		D	
	in	mm	in	mm	in	mm	in	mm
JPL-0004	28-1/8	714	7-1/4	184	5-1/4	133	3-1/2	89
JPL-0010	31-3/8	797	7-1/2	191	6-3/8	162	4	102
JPL-0016	33-7/8	860	8-3/4	222	7	178	4-1/2	114
JPL-0028	38	965	10-7/8	276	7	178	5-9/16	141
JPL-0038	42-1/4	1073	12-3/8	314	7	178	6-5/8	168
JPL-0060	51-7/8	1318	15-3/4	400	7-1/4	184	8-5/8	219
JPL-0085	59-1/4	1505	15-3/4	400	8	203	8-5/8	219
JPL-0130	61-1/4	1556	15-3/4	400	8	203	8-5/8	219
JPL-0200	75-5/8	1921	19-3/8	492	8-3/4	222	10-3/4	273

Inlet/Outlet Pressure Gauges with Petcock Valves

Included as standard; Install at both inlet and outlet for proper flow verification (see "Flow vs. Pressure Loss", page 3)

Vortube

Piping provided by LAKOS

Manual Isolation Valve

Included as standard to provide for removal of Auto Purge valve for servicing; Also included with separator are the following threaded reducers: 2" x 1-1/2", 2" x 1" and 2" x 3/4" for your choice of purge equipment

Note: These units may also be specified with optional support skirt or legs. Consult factory for details.

Low Profile

High Flow Rates

Inlet/Outlet Pressure Gauges with Petcock Valves

Included as standard; Install at both inlet and outlet for proper flow verification (see "Flow vs. Pressure Loss", page 3)

Inspection/Drain Plug

1/2-inch NPT female; provides access to upper chamber for inspection of slot area; also allows for draining the upper chamber if necessary

Vortube

Piping provided by LAKOS

Hand-Hole Inspection Port

Provides access to collection chamber

Lifting Ring

For installation purposes

Manual Isolation Valve

Included as standard to provide for removal of Auto Purge valve for servicing

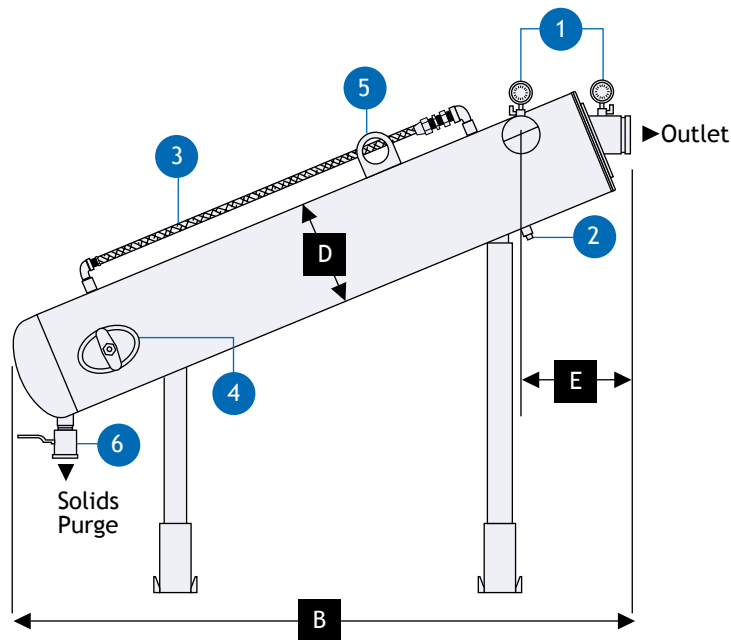
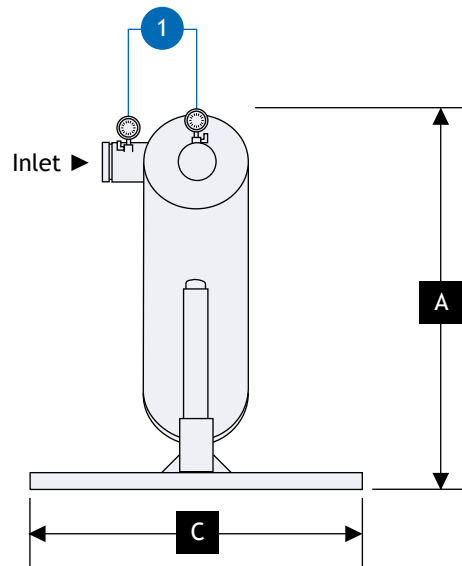

Dimensions

Model	A		B		C		D		E	
	in	mm	in	mm	in	mm	in	mm	in	mm
JPL-0285-L	76-1/8	1934	78	1981	40	1016	12-3/4	324	15	381
JPL-0450-L	83-1/4	2115	94-1/2	2400	40	1016	14	356	16	406
JPL-0650-L	89-3/4	2280	105-3/4	2686	40	1016	16	406	18	457
JPL-1160-L	101-1/4	2572	126-3/4	3219	40	1016	20	508	22	559
JPL-1850-L	110	2794	141-5/8	3597	40	1016	24	610	26	660
JPL-2650-L	119-5/8	3038	158	4013	60	1524	28	711	30	762
JPL-4200-L	142-7/8	3629	198	5029	60	1524	36	914	38-1/2	978
JPL-6700-L	161-7/8	4112	234	5944	60	1524	42	1067	44	1118

High Flow Rates

Vertical Profile

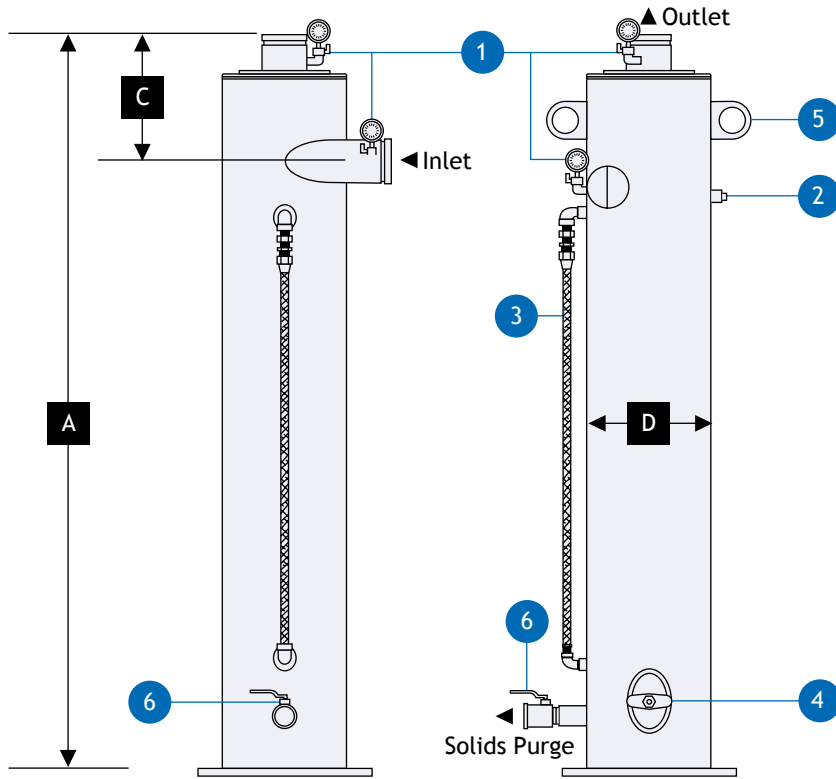

1 Inlet/Outlet Pressure Gauges with Petcock Valves

Included as standard; Install at both inlet and outlet for proper flow verification (see "Flow vs. Pressure Loss", page 3)

2 Inspection/Drain Plug

1/2-inch NPT female; provides access to upper chamber for inspection of slot area; also allows for draining the upper chamber if necessary

3 Vortube

Piping provided by LAKOS

4 Hand-Hole Inspection Port

Provides access to collection chamber

5 Lifting Rings

For installation purposes

6 Manual Isolation Valve

Included as standard to provide for removal of Auto Purge valve for servicing

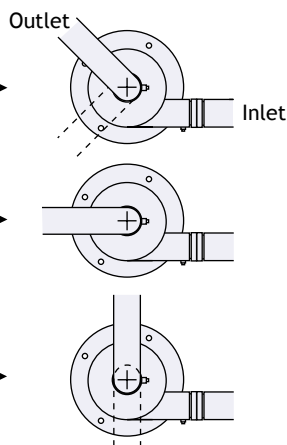

Recommended Direction of Inlet/Outlet Piping to Control Vibration

Top Views

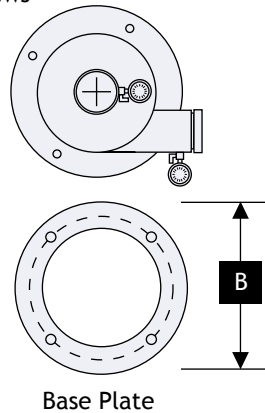

Dimensions

Model	A		B		C		D	
	in	mm	in	mm	in	mm	in	mm
JPL-0285-V	76	1930	18	457	13	330	12-3/4	324
JPL-0450-V	93-1/2	2375	20	508	12-1/2	318	14	356
JPL-0650-V	105-3/4	2686	22	559	14-7/8	378	16	406
JPL-1160-V	126-3/8	3210	26	660	17-3/4	451	20	508
JPL-1850-V	139-1/2	3543	32	813	20	508	24	610
JPL-2650-V	155-1/2	3950	36	914	23	584	28	711
JPL-4200-V	194-1/2	4940	44	1118	29	737	36	914
JPL-6700-V	229	5817	48	1219	33-3/4	832	42	1067

Sample Specifications

Limited Warranty

All products manufactured and marketed by this corporation are warranted to be free of defects in material or workmanship for a period of at least one year from date of delivery. Extended warranty coverage applies as follows:

All LAKOS Separators: Five year warranty

All other components: 12 months from date of installation; if installed 6 months or more after ship date, warranty shall be a maximum of 18 months from ship date.

If a fault develops, notify us, giving a complete description of the alleged malfunction. Include the model number(s), date of delivery and operating conditions of subject product(s). We will subsequently review this information and, at our option, supply you with either servicing data or shipping instruction and returned materials authorization. Upon prepaid receipt of subject product(s) at the instructed destination, we will then either repair or replace such product(s), at our option, and if determined to be a warranted defect, we will perform such necessary product repairs or replace such product(s) at our expense.

This limited warranty does not cover any products, damages or injuries resulting from misuse, neglect, normal expected wear, chemically-caused corrosion, improper installation or operation contrary to factory recommendation. Nor does it cover equipment that has been modified, tampered with or altered without authorization.

No other extended liabilities are stated or implied and this warranty in no event covers incidental or consequential damages, injuries or costs resulting from any such defective product(s).

1365 North Clovis Avenue
Fresno, California 93727 USA
Telephone: (559) 255-1601
FAX: (559) 255-8093
Toll Free: (800) 344-7205
(USA, Mexico & Canada)
Internet: www.lakos.com
E-mail: info@lakos.com

Separator Type & Performance

The removal of specific unwanted solids from a pumped/pressurized fluid flow system shall be accomplished with a centrifugal-action vortex separator. Solids removal efficiency is principally predicated on the difference in specific gravity between the liquid and the solids. Fluid viscosity must be 100 SSU or less.

In a single pass through the separator, given solids with a specific gravity of 2.6 and water at 1.0, performance is predictably 98% of 74 microns and larger. Additionally, particles finer in size, heavier by specific gravity and some lighter by specific gravity will also be removed, resulting in an appreciable aggregate removal of particles (up to 75%) as fine as 5 microns.

In a recirculating system, 98% performance is predictable to as fine as 40 microns (given solids with a specific gravity of 2.6), with correspondingly higher aggregate performance percentages (up to 90%) of solids as fine as 5 microns.

Separator Design & Function

A tangential inlet and mutually tangential internal accelerating slots shall be employed to promote the proper velocity necessary for the removal of the separable solids. The internal accelerating slots shall be spiral-cut (Swirlax) for optimum flow transfer, laminar action and particle influence into the separation barrel. The separator's internal vortex shall allow this process to occur without wear to the accelerating slots.

Separated particle matter shall spiral downward along the perimeter of the inner separation barrel, in a manner that does not promote wear of the separation barrel, and into the solids collection chamber, located below the vortex deflector stool.

To insure maximum particle removal characteristics, the separator shall incorporate a vortex-induced pressure relief line (Vortube), drawing specific pressure and fluid from the separator's solids collection chamber via the outlet flow's vortex/venturi effect, thereby efficiently encouraging solids into the collection chamber without requiring a continuous underflow or excessive system fluid loss.

System fluid shall exit the separator by following the center vortex in the separation barrel and spiral upward to the separator outlet.

Purging (as a specified option)

Evacuation of separated solids shall be accomplished automatically, employing a dedicated solid-state controller in a NEMA 4 housing. Available for worldwide single-phase voltages of 24VAC to 250VAC.

Programming options to include a purge frequency range of every 60 seconds to every 23 hours, 59 minutes. Purge duration options range from 2 seconds to 59 minutes, 59 seconds. Non-volatile memory. Meets CSA requirements. This controller shall automatically operate one of the following techniques:

Motorized Ball Valve - A full-port, electrically-actuated valve shall be programmed at appropriate intervals and duration in order to efficiently and regularly purge solids from the separator's collection chamber. Valve body shall be bronze (optional stainless steel also available). Valve ball shall be stainless steel with teflon seat. Valve size: _____

Pneumatic Pinch Valve - Compressed air shall be provided to actuate this full-port valve at appropriate intervals and duration in order to efficiently and regularly purge solids from the separator's collection chamber. System shall include a pressure regulator for proper modulation of air pressure. Valve liner is natural gum rubber (other liner materials available). Valve size: _____

Pneumatic Ball Valve - A fail-safe valve shall be programmed at appropriate intervals and duration in order to efficiently and regularly purge solids from the separator's collection chamber. A spring-control shall provide that this full-port valve closes in the event that compressed air or electricity is interrupted. Valve body shall be bronze (optional stainless steel also available). Valve ball shall be stainless steel with teflon seat. Valve size: _____

Purge Liquid Concentrator - A dual pneumatic pinch valve package shall be employed in order to effectively minimize the fluid loss when purging. The controller shall provide proper sequential valve actuation at appropriate intervals and duration in order to efficiently and regularly evacuate solids from the separator's collection chamber. Liners for the pinch valves shall be natural gum rubber (optional, at extra cost: neoprene, butyl, buna N and hypalon also may be specified). System shall also include a pressure regulator to modulate air pressure to the valves, a full-size sightglass for inspection of solids accumulation during operation and a manual isolation valve for servicing requirements. Valve size: _____

Solids Handling (as a specified option)

An appropriate solids collection device shall be provided with the separator, suitable for capturing solids and returning all excess purged liquid to system use. Size and type of collection device shall be determined according to the application requirements, selected from the following options (or custom, as specified):

Solids Collection Drum - In conjunction with the appropriate automatic purge valve, this package shall be employed to capture and concentrate separated solids (up to 90% solids by volume) from the separator directly into a standard 55-gallon drum, returning excess purged liquid to system use via an integral decant line on the drum shroud. Solids collection capacity: 12,700 cubic inches (200 liters). Package includes two shrouds, two shroud clamps, two drum carts for transporting the drums and a manual liquid evacuation pump. Recommended option: A Purge Diffuser shall be installed on the discharge of the automatic purge valve in order to reduce the velocity of the purge flow and enhance the settling of solids within the drum.

Solids Collection Hopper - In conjunction with the appropriate automatic purge valve, a one cubic yard (764 liter) hopper shall be employed to capture and concentrate separated solids (up to 90% by volume) from the separator, returning excess purged liquid to system use via an integral decant line installed directly on the hopper. The hopper shall feature a manually-actuated tilting mechanism for dumping accumulated solids as necessary. Recommended option: A Purge Diffuser shall be installed on the discharge of the automatic purge valve in order to reduce the velocity of the purge flow and enhance the settling of solids within the hopper.

Systemization (as a specified option)

The separator and its accessories shall be packaged as a complete system, with all componentry from a single source. In addition to the equipment already specified, the system shall also include an appropriate support frame for positioning the separator accurately and effectively for solids purging/handling. If the specified purging technique is a pneumatic pinch valve: A spare pinch valve liner shall also be included.

Separator Details

A. Inlet & outlet shall be grooved couplings,

size: _____

B. Purge outlet shall be threaded with screw-on flange,

size: _____

C. The separator shall operate within a flow range of: _____

D. Pressure loss shall be between 3-12 psi (.2 - .8 bar), remaining constant, varying only when the flow rate changes.

E. Included shall be pressure gauges with petcock valves for both the inlet and outlet of the separator and an isolation valve at the purge outlet for servicing of the automatic valve as necessary without interrupting system flow.

Separator Construction

The separator shall feature the following access capabilities for either inspection or the removal of unusual solids/debris:

- A hand-hole port at the collection chamber, with Neoprene gasket (except low flow units)
- An inspection port, located at the lowest point of the upper chamber

The separator shall be of unishell construction with A-36, A-53B or equivalent quality carbon steel, minimum thickness of .25 inches (6.35 mm). Maximum operating pressure shall be 150 psi (10.3 bar), unless specified otherwise.

Paint coating shall be oil-based enamel, spray-on, royal blue.

As a specified option only: The separator shall be constructed in accordance with the standards of the American Society of Mechanical Engineers (ASME), Section VIII, Division 1 for pressure vessels. Certification shall be confirmed with the registered "U-stamp" on the body of the separator. Weld-on flanges also available.

Separator Source & Identification

The separator shall be manufactured by LAKOS Filtration Systems, a division of Claude Laval Corporation in Fresno, California USA. Specific model designation is: _____